

Subject to technical changes and to the availability of the accessories supplied with the instruments.

CITIZEN SCALE (I) PVT. LTD.

Parwanoo. Tel. : 022 - 4243 7777 | Fax : 022 - 4243 7900 | Email: service@citizenscales.com | Web: www.citizenscales.com

CS-09-05-11/2



Citizen[®]
ISO 9001 : 2008 CERTIFIED

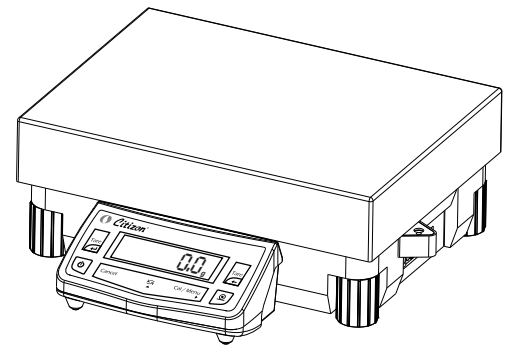
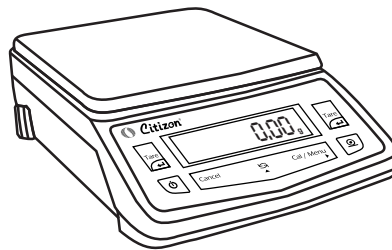
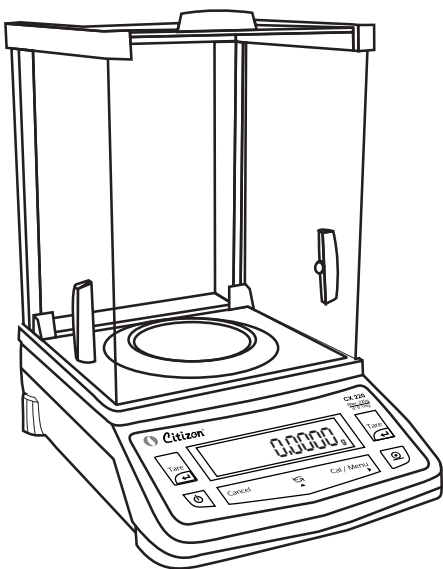

Analytical Balances | Carat Balances | Precision Balances | High Precision Industrial Balances

Operating Manual

Contents

1	Introduction	3
1.1	Warning & Safety Precautions	4
1.2	Getting Started	5
1.3	Layout	6
2	Setting up the Balance	9
2.1	Location	12
2.2	Warm up	14
2.3	Keys of Balance	15
3	Power On	17
4	Simple Weighing	19
4.1	External Calibration	23
4.2	Internal Calibration	25
4.3	Calibration Test	27
4.4	Calibration Test with Actual Calibration	29
5	Overview of Menu	32
5.1	Operating Instruction	33
5.2	Description of Menu	34
6	Functions	44
6.1	Piece Counting	44
6.2	Percent Weighing (%)	49
6.3	Custom Units	57
6.4	Animal Weighing	61
6.5	Formulation	65
6.6	Check weighing	69

6.7	Totalization	73
6.8	Density Determination	77
6.9	Pipette Calibration	83
6.10	Statistics	89
7	Parameter Settings	93
7.1	Time & Date Settings	96
7.2	ID / LID Settings	98
7.3	Auto Calibration	99
7.4	Windows Direct Communication	102
8	ISO / GLP - Compliant Printout	105
9	Data Interface	107
9.1	Data Output Format	108
9.2	Data Input Format	110
9.3	Cabling Diagram	111
10	Error Codes	112
11	Care & Maintenance	114
12	Dimensional Drawings	119
13	Specification	123
14	Accessories	134

1. Introduction

The models of the CX, CY, CT, CG and SSH Series are weighing instruments of special and high accuracy designed for the measurement of mass, covering a range from 0.01 mg to 100 kg.

CX, CY, CT, CG and SSH models meet the highest requirements on the accuracy and reliability of weighing results through the following features:

- Filtering for unfavorable ambient conditions, such as vibration, drafts, etc.
- Stable and repeatable weighing results
- Excellent readability under any lighting conditions
- Rugged, durable weighing system

These weighing instruments speed up your simple routine applications through following features:

- Extremely fast response times
- Built-in applications
 - Counting
 - Percent weighing
 - Animal weighing
 - Formulation
 - Totalization
 - Custom Unit
 - Check Weighing
 - Density Determination
 - Pipette Calibration
 - Statistics



- Total ease of operation
- Direct Communication with MS Excel, MS Word and other windows application.
- ISO/GLP-compliant recording capability for printouts
- Serial RS-232 port for optional connection to a PC or Printer.
- Optional USB interface available on request.

1.1 Warnings and Safety precautions

The balance has been constructed in accordance with the European Directives as well as international regulations and standards for operation of electrical equipment, electromagnetic compatibility, and stipulated safety requirements. Improper use or handling, however, can result in damage and/or injury.

To prevent damage to the equipment, please read these operating instructions carefully before using your balance.

Keep these instructions in a safe place. Follow the instructions below to ensure safe and trouble-free operation of your balance.

-  Do not use this balance/scale in a hazardous area/location.
-  If you use electrical equipment in installations and under ambient conditions requiring higher safety standards, you must comply with the provisions as specified in the applicable regulations for installation in your country.

 Make sure that the voltage rating printed on the AC adapter is identical to your local line voltage.

 Warning when using pre-wired RS-232 connecting cables: The pin assignments in RS-232 cables purchased from other manufacturers may be incompatible with Citizen balances. Be sure to check the pin assignment against the chart on page 111 before connecting the cable.

- The only way to switch the power off completely is to disconnect the AC adapter.
- Connect only Citizen accessories and options, as these are optimally designed for use with your Citizen balances.
- Note on Installation: The operator shall be responsible for any modifications to Citizen equipment and for any connections of cables or equipment not supplied

by Citizen and must check and, if necessary, correct these modifications and connections. On request, Citizen will provide information on the minimum operating specifications

- Protect the DC adapter and the weighing instrument from contact with liquids.
- When cleaning your balance, make sure that no liquid enters the balance housing; use only a slightly moistened cloth to clean the balance.
- Do not open the balance/scale housing. If the seal is broken, this will result in forfeiture of all claims under the manufacturer's warranty.
- If you have any problems with your balance contact your local Citizen office, dealer or service center

1.2 Getting Started

Storage and Shipping Conditions

Do not expose the balance/scale to extreme temperatures, blows, shocks, vibration or moisture.

Unpacking the Equipment

After unpacking the balance/scale, check it immediately for any visible damage as a result of rough handling during shipment

If you see any sign of damage: Contact your local Citizen office, dealer or service center

It is a good idea to save the box and all parts of the packaging until you have successfully installed your balance. Only the original packaging provides the best protection for shipment. Before packing your balance, unplug all connected cables to prevent damage.

Accessories Supplied

The equipment supplied includes the following :

- Balance with display and control unit
- Operating Manual
- DC adapter
- Gem bowl (CT scales only)
- Pan Support (CX / CY / CT)
- Weighing pan
- Draft shield (CX / CY / CT)
- Wind Shield (CX / CY / CT)
- Base Plat S.S. (CX / CY / CT)
- Pan Cover (CX / CT)
- 1 Pair of Corner hole Cover (CX / CY / CT)

⚠ Cautionary notes

Citizen balances may not be operated in hazardous areas.

Before attachment of the DC adapter, check whether the imprinted voltage value matches the local supply voltage. If it does not, contact your local CITIZEN dealers.

CITIZEN balance may only be used indoor in dry environment.

1.3 Layout

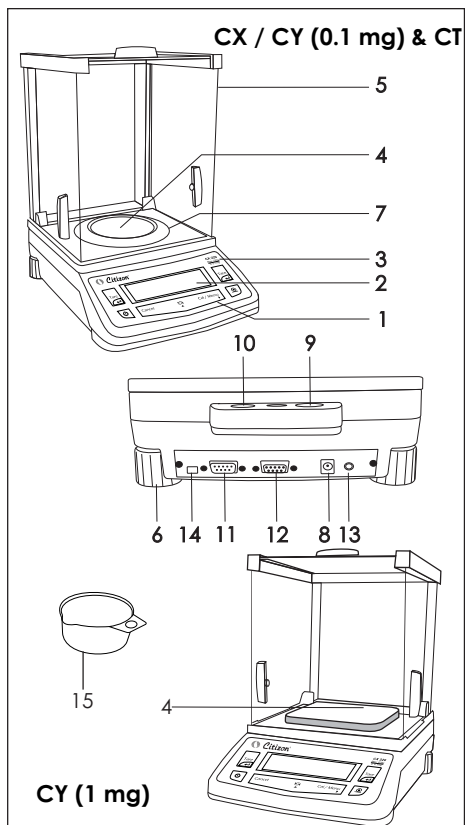

CX / CY (0.1 mg) & CT

1. Keypad
2. Display
3. Model plate
4. Weighing pan (90 Fmm)
5. Draft shield (CX, CY & CT)
6. Leveling feet
7. Pan Cover
8. DC adapter socket
9. Provision for anti-theft device
10. Spirit Level
11. RS232C interface
12. Additional Display Sockets.
13. Foot Tare Switch Socket.
14. Calibration Switch (for Verified Balance)
15. Gem Bowl (CT)

Keys, operation and display are identical for all CITIZEN balances.

CY (1 mg with Draft shield)

1. Keypad
2. Display
3. Model plate
4. Weighing pan (128mm x 128mm)
5. Draft shield (CX, CY & CT)
6. Leveling feet
8. DC adapter socket
9. Provision for anti-theft device
10. Spirit Level
11. RS232C interface
12. Additional Display Sockets.
13. Foot Tare Switch Socket.
14. Calibration Switch (for Verified Balance)

Keys, operation and display are identical for all CITIZEN balances.

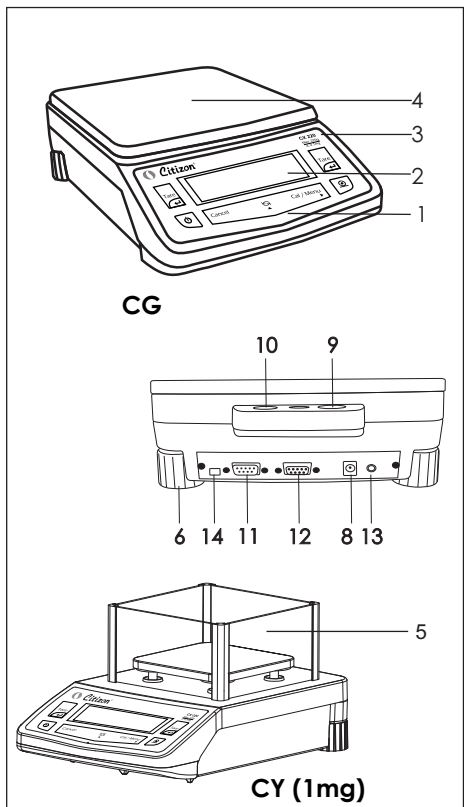

CG

1. Keypad
2. Display
3. Model plate
4. Weighing pan (198 mmX 205 mm)
6. Leveling feet
8. DC adapter socket
9. Provision for anti-theft device
10. Spirit Level
11. RS232C interface
12. Additional Display Sockets.
13. Foot Tare Switch Socket.
14. Calibration Switch (for Verified Balance)

Keys, operation and display are identical for all CITIZEN balances.

CY (1 mg with wind shield)

1. Keypad
2. Display
3. Model plate
4. Weighing pan (128mm x 128mm)
5. Wind shield (CX, CY & CT)
6. Leveling feet
8. DC adapter socket
9. Provision for anti-theft device
10. Spirit Level
11. RS232C interface
12. Additional Display Sockets.
13. Foot Tare Switch Socket.
14. Calibration Switch (for Verified Balance)

Keys, operation and display are identical for all CITIZEN balances.

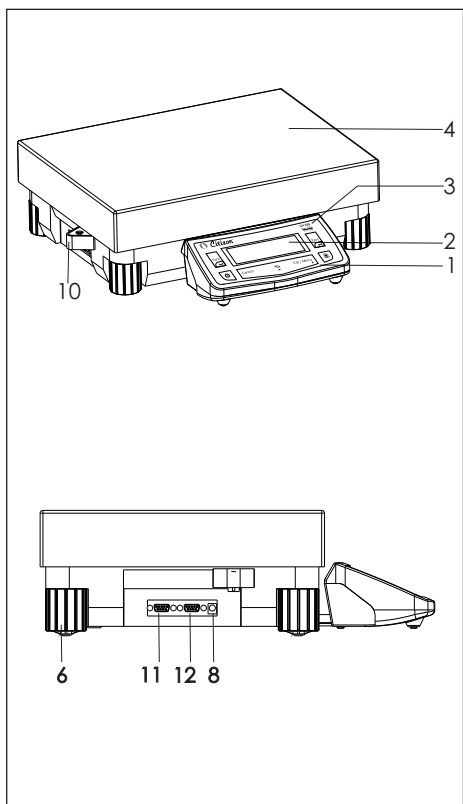

SSH

1. Keypad
2. Display
3. Model plate
4. Weighing pan (400mm x 300mm)
6. Leveling feet
8. DC adapter socket
9. Provision for anti-theft device
10. Spirit Level
11. RS232C interface
12. Additional Display Sockets.
13. Foot Tare Switch Socket.
14. Calibration Switch (for Verified Balance)

Keys, operation and display are identical for all CITIZEN balances.

2. Setting Up the balance

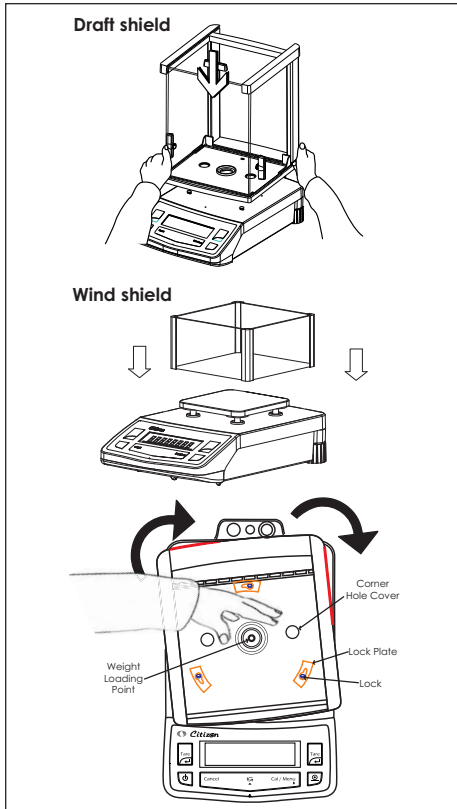

Balance with Analytical Draft-Shield (or Wind Shield) Chamber

- Position the Draft shield carefully on the balance.

Step 1: Open your New balance and draft shield you will see lock mounted on balance body and lock plate mounted below draft shield .

Step 2: Put your draft shield in same place and direction guided through RED color lines marked on this sticker, with gentle hand push & rotate draft shield clock wise as shown in figure.

▲ : While keeping draft shield on balance ensure you do not damage weight loading point.

Note : Ensure there must not be any gap between balance and draft shield, if incase there is gap repeat again above procedure.

Step 3: Push fix both corner hole cover on bottom body of draft shield as shown in figure.

- The Procedure for setting up the balance with wind shield is same as that of one with draft shield

9

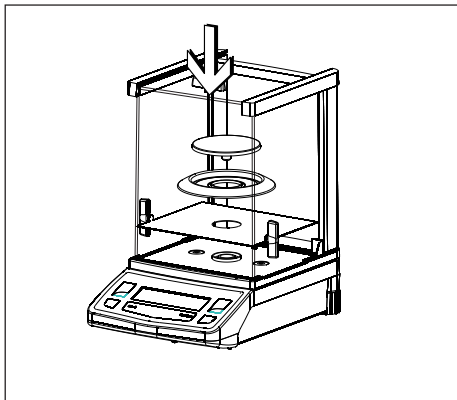

- Place the components listed below inside the chamber in the order given:
(For CX / CY (0.1mg) / CT Series Balances)

- Corner Cover
- Base plate
- Pan Cover
- Weighing pan

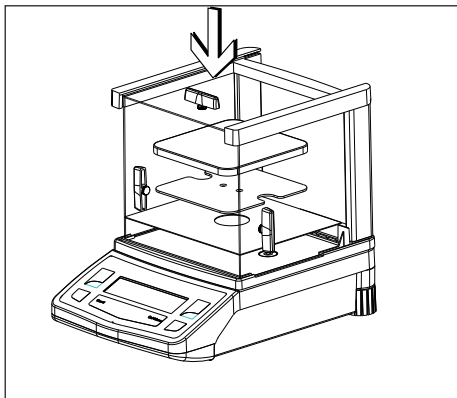

- Place the components listed below inside the chamber in the order given:
(For CY (1mg) Series Balances)

- Corner Cover
- Base plate
- Pan Support
- Weighing pan

10

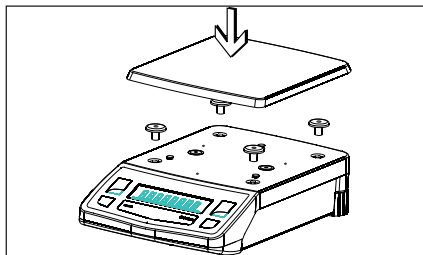

• **Place the components listed below inside the chamber in the order given:**
(For CG Series Balance)

- Bush
- Weighing pan

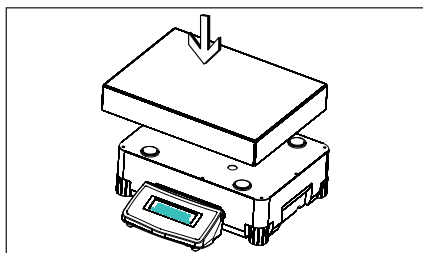

• **Balances with a Rectangular Weighing Pan and a Weighing Capacity over 10 kg**

- Place the weighing pan on the balance/scale

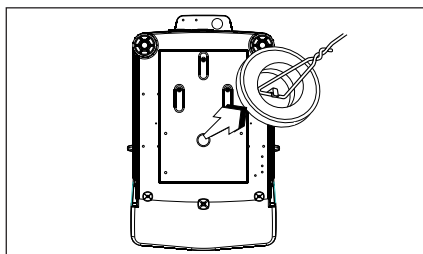

Under Weighing

A port for a under weighing hanger is located on the bottom of the balance.

- Remove the under weighing cover from the bottom of the balance (as shown alongside)
- Suspend the below-balance weighing hook supplied from the hanger
- If necessary, install a shield for protection against drafts

2.1 Location

The optimum location

The correct location makes an important contribution to the accuracy of the weighing results of high-resolution analytical and precision balances.

Hence, ensure a stable, vibration-free position as horizontal as possible.

Avoid

- Direct sunlight
- Excessive temperature fluctuations,
- Drafts (Power ----- Air Conditioning System, Fans can also cause drafts)

The best position is on a stable bench in a corner protected against drafts as far possible from doors, windows, radiators or the ventilation slots of air conditioners.

Anti-theft device

Citizen Balance are equipped with a lug for optional anti-theft device.

The anti-theft device (cable with lock) is suitable for all models. It is available from CITIZEN under order number CAD01.

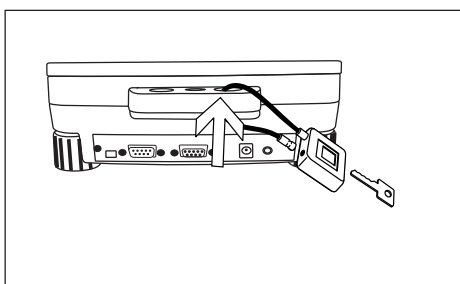
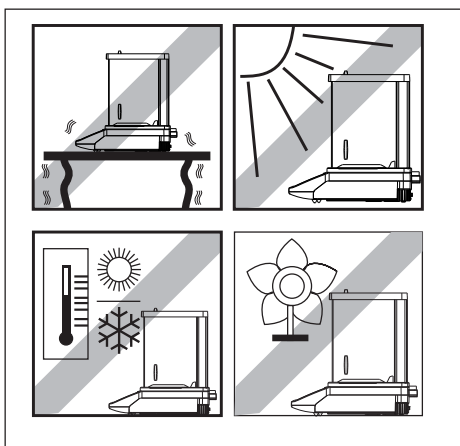

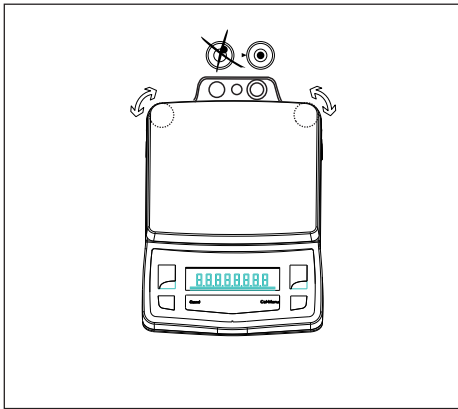

Leveling the Balance

Citizen balances have a level control and adjustable leveling feet to compensate for slight irregularities in the weighing bench surface. The balance is exactly horizontal when the air bubble is in middle.

Leveling Balances with a Weighing Capacity up to 10 kg

Turn the two leveling feet as desired picture in diagram so that air bubble comes in middle.

Air bubble at "12 o'clock"	Turn both leveling feet counter-clockwise.
Air bubble at "3 o'clock"	Turn left leveling foot clockwise, right leveling foot counterclockwise
Air bubble at "6 o'clock"	Turn both leveling feet clockwise
Air bubble at "9 o'clock"	Turn left leveling foot clockwise, right leveling foot counterclockwise

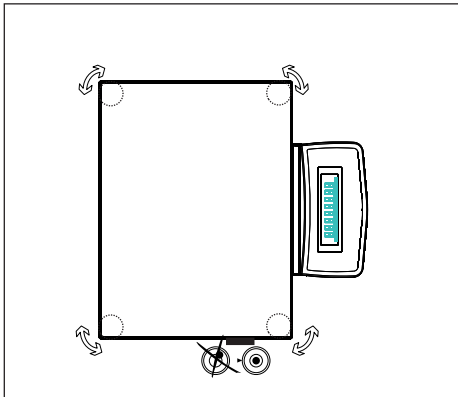

Leveling Balances with a Weighing Capacity over 10 kg

- Adjust the leveling feet until the air bubble is centered within the circle of the level indicator

Note : The balance must be re-leveled each time it is moved to a new location.

2.2 Warm Up

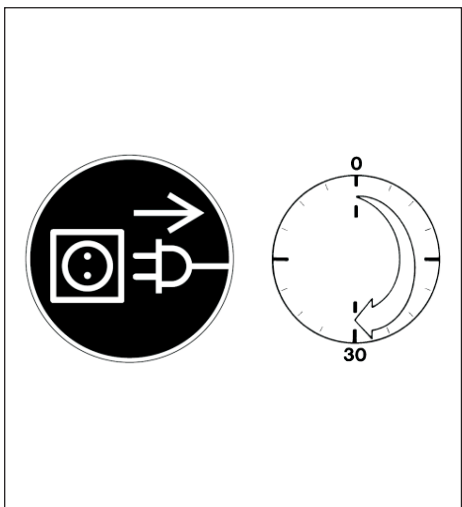

Connecting Electronic Peripheral Devices

Make absolutely sure to unplug the balance from DC power before you connect or disconnect a peripheral device (printer or PC) to or from the interface port.

Warmup Time

To deliver exact results, balance must warm up to operating temperature for as leasted below before the first weighing operation is carried out.

- CX / CY (0.1mg) / CT all Analytical models: at least 60 minutes
- CY (1mg) / CG / SSH all Precision models: at least 30 minutes

Using Verified Balances as Legal Measuring Instruments in the EU* balance must warm up for at least 24 hours after initial connection to DC power.

2.3 Keys of Balance

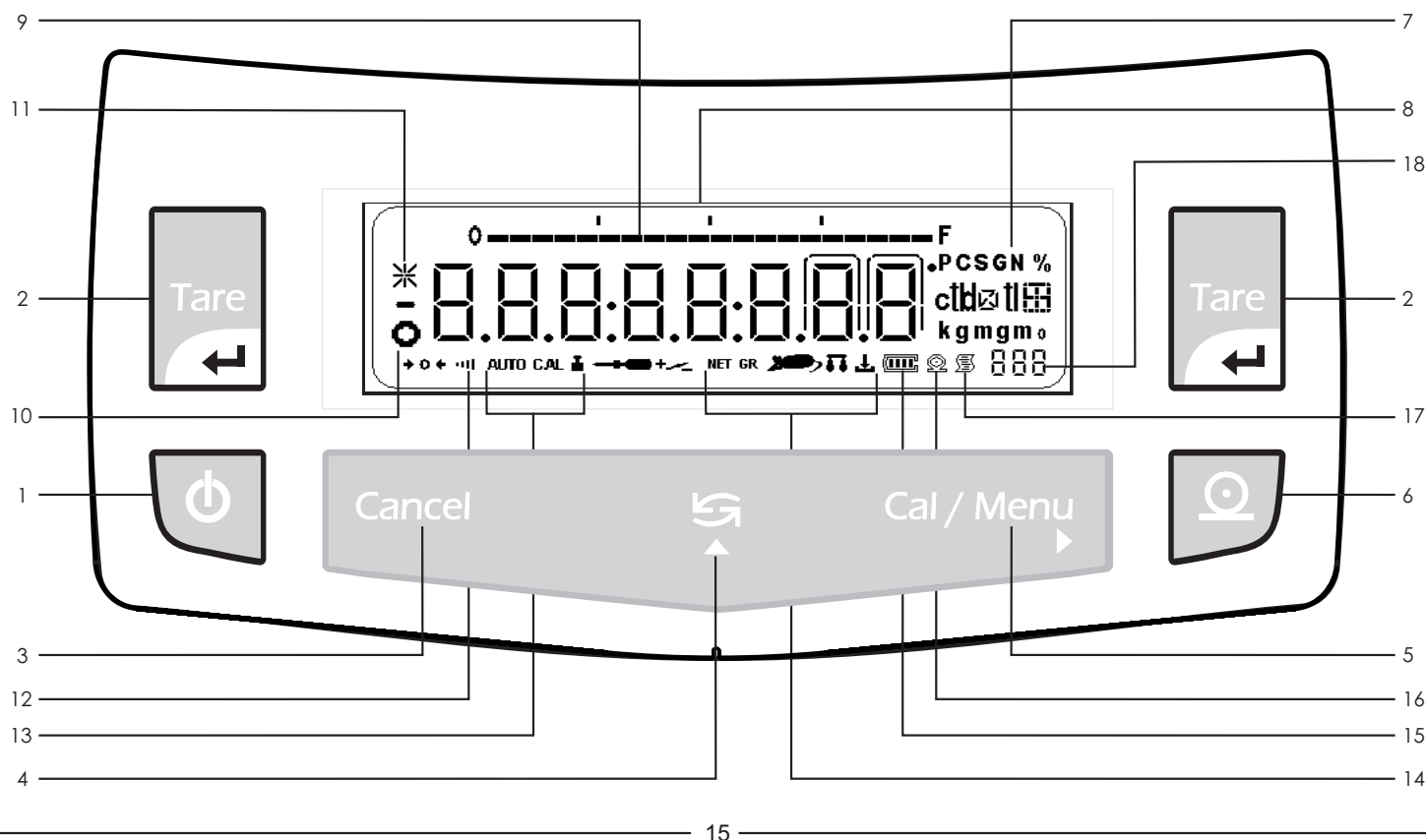

- 1 On/Off key: Switches the display on / off
- 2 Tare key: Press here to tare the weight of any container so that the readout shows the net weight of samples, also used to store reference settings. This key used to delete the statistics when F StAt mode.
- 3 Cancel Function : Delete (Clear Function) This key is generally used to interrupt/cancel functions; for example: – to end an application program – to interrupt calibration/ adjustment routines
- 4 Toggle Key : Press here to change the Unit, Also used to increment digit.
- 5 Cal Menu Function : Press here to start calibration/ adjustment or to enter user menu, Also use to shift flashing digit from left to right. this key is used in the F PiP mode to accept the volume during the calibration procedure.
- 6 Print Key : Press this key to send displayed values over the built-in data interface to a DataPrint printer or a PC.
- 7 Weight Units
- 8 Weight readout in the selected weight unit

- 9 Capacity Bar : This indicates the total amount of weight on the Pan
- 10 Stability Symbol : This symbol is displayed when the weight place on the pan achieve stability
- 11 Asterik Symbol : This Symbol is displayed when the display is locked
- 12 Stability Filer : This symbol indicates the chosen stability filter
- 13 Symbol indicating that the Auto / Manual calibration/adjustment function is active
- 14 Symbol indicating the active program
- 15 Battery Level Indicator : This symbol is indicates the Current charge of the battery
- 16 Symbol indicating that a printout is being generated
- 17 Symbol indicating that a GLP compliant printout is being generated
- 18 Seven segment readout indicating the active program

3. Power ON

Connect DC Adaptor and Power ON the balance.

- It will display version number for software
- It will display numeric countdown
- It will display 88888888
- The system initialization process will begin with the display indicating the current progress. (INIT 1% to INIT 100%)
- After the initialization is complete (100%) It will enter stand by mode & display clock.

Stand by Mode

- After Power ON and initial test balance will automatically come in stand by mode.
- Press ON / OFF key to come to basic weighing
- Press ON / OFF key in basic weighing to come back to Stand by Mode

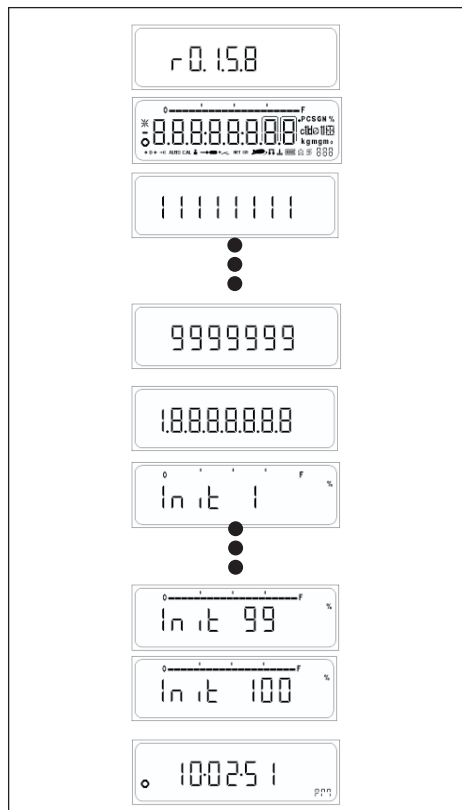

Key Functionality in simple weighing mode

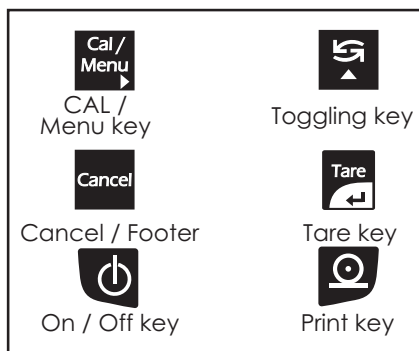
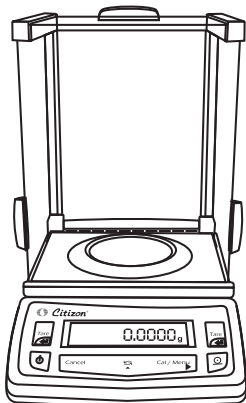

Short-form operating Instructions

- Press key **briefly**
- Press and **hold** key until desired display appears
- Automatic procedure

Citizen balances have several control levels the following section explains key functionality in simple weighing mode.

Weighing mode (operation)	
Press briefly	Press & Hold
Switch on & off	
Switch References	
Change Weighing Unit	
	Calibrate (adjust)
	Call Menu
Print Weighing Results	
Tare	
Confirm Setting	Confirm Reference Setting
Abort / Cancel and Footer when GLP is ON	

4. Simple Weighing

Purpose

The basic weighing function is always accessible and can be used alone or in combination with an application program (counting, weighing in percent, etc.).

Features

- Taring the balance you can tare the balance within the entire weighing range.
- Assigning IDs to weights (as needed)
- Printing weights

Simple Weighing

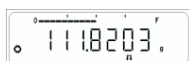
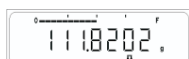
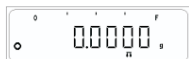

4.0.1 Simple weighing

- ⇒ Place weighing sample on the weighing pan.
- ⇒ Wait until the stability symbol appears
- ⇒ Read the result.
- ⇒ Bar Graph will glow according to weight kept ON the PAN.

Taring

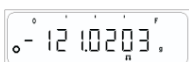
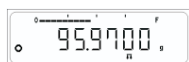
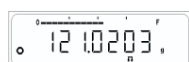
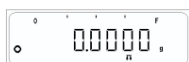

4.0.2 Taring

- ⇒ Place empty container on the balance.
- ⇒ The weight is displayed.
- ⇒ Press <Tare> key briefly, the balance displays zero
- ⇒ Add weighing sample to container, the net weight is displayed.

If the container is removed from the balance, the tare weight will be shown as a negative value.

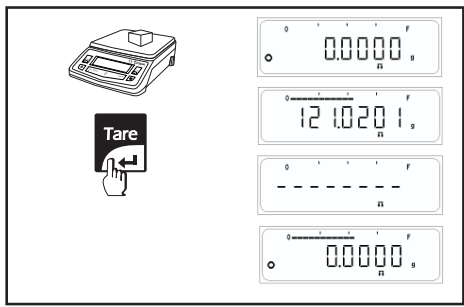

In case if stability is not achieved & user presses <TARE> key, display will shows "-----" until stability is achieved.

Display then shows "0.0000 gm"

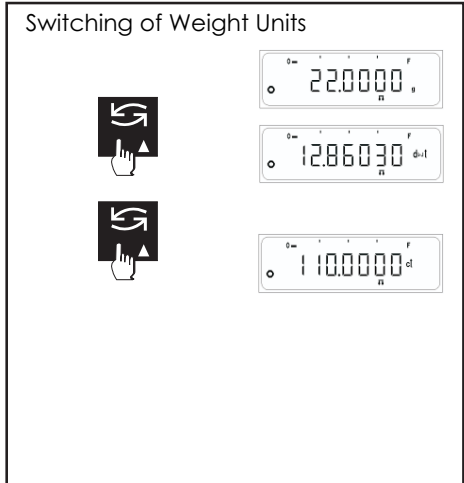

4.0.3 Switching of weight units

All Citizen balances can display weight values in different weight units.

The **factory setting** is Unit 1 (gm), Unit 2 (ct), Unit 3 (gm)

Switching between unit 1, unit 2 and unit 3

- ⇒ Press <TOGGLE> key the display switches to the 2nd weight unit.
- ⇒ Press <TOGGLE> key again, the display switches to the 3rd weight unit. OR Application unit (If same is selected in menu)

Note : With **certified balances** the unit selection can be blocked following installation if required by national legislation.

4.0.4 Simple weighing Print out

When GLP ON

Print out generated when Unit Toggling is done between Unit1 (g), Unit2 (ct), Unit3 (Oz) in Simple Weighing.

```

-----
20-Jul-10      10:35AM
      Citizen
Model         CX 220
Ser.no.       9223102
Ver.no.       r0.1.5.3
ID            1234567
-----
LID:          1111111
+            49.9999 g
+            249.9990 ct
+            1.763690 oz
+            49.9998 g
+            249.9990 ct
+            1.763690 oz
+            49.9999 g
-----
20-Jul-10      10:36AM
Name:         .....
-----

```

When GLP OFF

Print out generated when Unit Toggling is done between Unit1 (g), Unit2 (ct), Unit3 (Oz) in Simple Weighing.

```

+            49.9999 g
+            249.9990 ct
+            1.763690 oz
+            49.9998 g
+            249.9990 ct
+            1.763690 oz
+            49.9999 g

```

Note : 1) User cannot enter into the external calibration or menu when GLP is ON & footer has not been printed.
2) To print footer user will have to Press <CANCEL> key.

4.1 External Calibration (adjusting)

Calibration

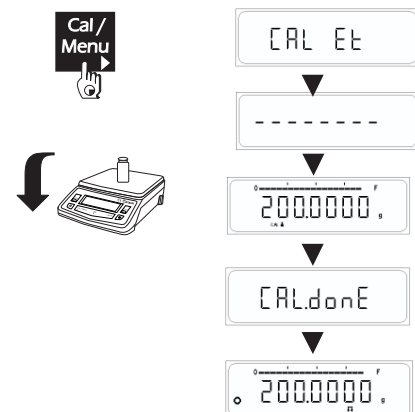

To obtain weighing results, the balance must be matched to the acceleration due to gravity at its location.

Calibration is necessary

- ⇒ Before the balance is used for the first time.
- ⇒ At regular intervals during weighing operation.
- ⇒ After a change in location.

Procedure

To obtain accurate results, the balance must be connected to the power supply and allowed to warm up to the operating temperature as described on Page No 14

Ensure that the weighing pan is unloaded and close the doors of the draft shield (if used). Balance should be Zero before calibration.

- ⇒ Have required calibration weight ready
- ⇒ Press and hold <CAL> key, display, shows "CAL Et"
- ⇒ Release <CAL> key now.
- ⇒ The required calibration weight value will be displayed.
- ⇒ Place calibration weight in center of pan.

The calibration (adjustment) is finished when "CAL donE" message is displayed. The balance is again in the weighing mode and ready for operation.

Note : With certified balances, the calibration can be disabled after installation if required by the national certification regulations.

The adjustment can be terminated at any time using the <CANCEL> key. The following message appears : 'Abort'

Calibration Report

If Balance is connected externally to PC or Data Printer via Rs232 Cable, successful or unsuccessful calibration report will be automatically generated after the completion of Calibration process.

Successful Calibration

When GLP ON

```
-----
14-Jul-10      03:46PM
      Citizen
Model          CX220
Ser.no.        9930508
Ver.no.        R0.1.04
ID             1234567
-----
```

Calibration: External

```
W-ID .....
Temperature    32.898'C
Set            + 20.00g
Diff.          0.00g
External Cal Done
```

Diff. 0.00g

```
-----
14-Jul-09      03:46PM
Name: .....
```

When GLP OFF

Calibration : External

W-ID

```
Temperature    32.905'C
Set            + 20.00g
Diff.          -0.01g
External Cal Done
Diff.          0.00g
```

Unsuccessful Calibration

When GLP ON

```
-----
14-Jul-10      03:46PM
      Citizen
Model          CX 220
Ser.no.        9930508
Ver.no.        R0.1.04
ID             1234567
-----
```

Calibration: External

```
W-ID .....
Temperature    32.898'C
Set            + 20.00g
```

External Cal Failed

```
-----
14-Jul-09      03:46PM
Name: .....
```

When GLP OFF

Calibration : External

W-ID

```
Temperature    32.905'C
Set            + 20.00g
```

External Cal Failed

4.2 Internal Calibration

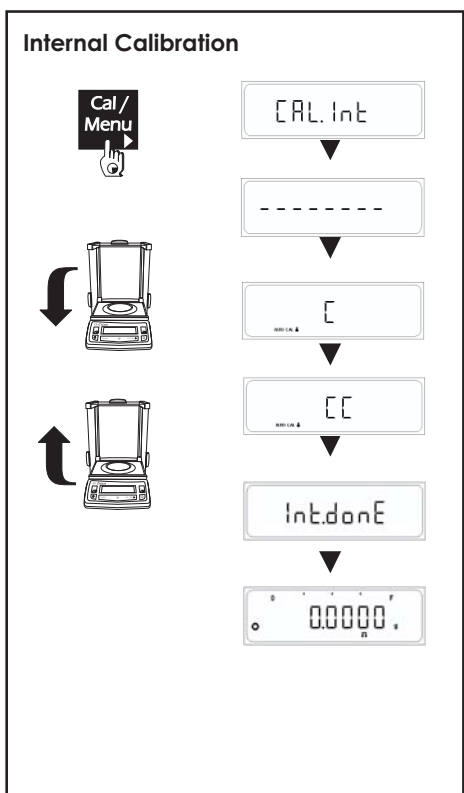

To obtain weighing results, the balance must be matched to the acceleration due to gravity at its location.

Calibration is necessary

- ⇒ Before the balance is used for the first time.
- ⇒ At regular intervals during weighing operation.
- ⇒ After a change in location.

Procedure

To obtain accurate results, the balance must be connected to the power supply and allowed to warm up to the operating temperature as described on Page No 14

Ensure that the weighing pan is unloaded and close the doors of the draft shield (if used). Balance should be Zero before calibration.

- ⇒ Press and hold <CAL> key, display, shows "CAL Int"
- ⇒ Release <CAL> key now.

Internal Calibration process Starts.....

- When the Internal Weight is being loaded "C" will be displayed on display.
- When the Internal Weight is being unloaded "CC" will be displayed on display.

Calibration is finished when 'Int.done' is message is displayed.

The adjustment can be terminated at any time using the <CANCEL> key. The following message appears : 'Abort'

Internal Calibration Report

If Balance is connected externally to PC or Printer via Rs232 Cable, successful or unsuccessful calibration report will be automatically generated after the completion of Calibration process.

Successful Calibration

When GLP ON

```
-----
20-Jul-10    10:32AM
      Citizen
Model       CX 220
Ser.no.    9223102
Ver.no.    r0.1.5.3
ID         1234567
-----
```

Calibration: Internal

```
Start:      Manual
Temperature 29.449'C
Diff.      + 0.0009g
```

```
Internal Cal Done
Diff.      0.0000g
-----
```

```
20-Jul-10    10:32AM
Name:
-----
```

When GLP OFF

Calibration: Internal

```
Start:      Manual
Temperature 29.449'C
Diff.      + 0.0009g
```

```
Internal Cal Done
Diff.      0.0000g
```

Unsuccessful Calibration

When GLP ON

```
-----
20-Jul-10    10:34AM
      Citizen
Model       CX 220
Ser.no.    9223102
Ver.no.    r0.1.5.3
ID         1234567
-----
```

Calibration: Internal

```
Start:      Manual
Temperature 29.495'C
```

Internal Cal Failed

```
-----
20-Jul-10    10:34AM
Name:
-----
```

When GLP OFF

Calibration: Internal

```
Start:      Manual
Temperature 29.495'C
```

Internal Cal Failed

4.3 Calibration Test

Calibration test determines the difference between the actual weight and the measured weight. Calibration test can be turned ON or OFF from the user menu. When ON, cal test would be performed on external or internal calibration whichever is selected in User Menu.

Procedure

- ⇒ Have required calibration weight ready
- ⇒ Press and hold <CAL> key, display, shows "CAL Et"
- ⇒ Release <CAL> key now.
- ⇒ The required calibration weight is shown on the display.
- ⇒ Place calibration weight in center of pan.

- ⇒ After the cal Test procedure is completed the difference between the actual & the measured weight will be displayed on display.

The adjustment can be terminated at any time using the <CANCEL> key. The following message appears : 'Abort'

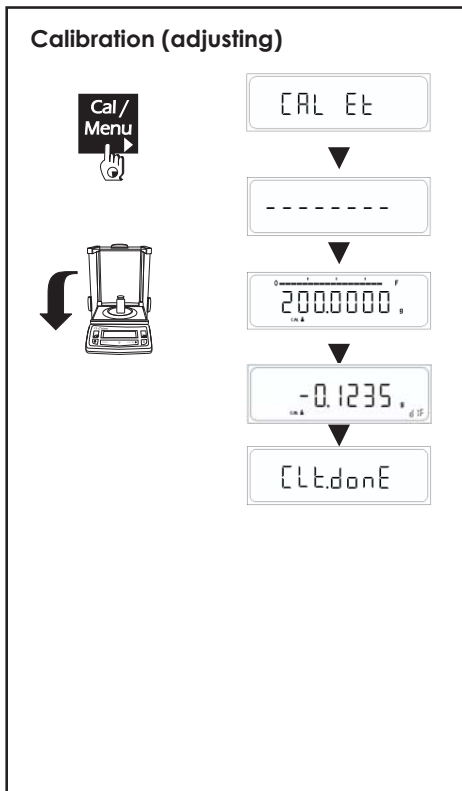

Calibration Test Report

If Balance is connected externally to PC or Data Printer via Rs232 Cable, successful or unsuccessful calibration report will be automatically generated after the completion of Calibration process.

When GLP ON

```

-----
14-Jul-10      00:03AM
      Citizen
Model         CX220
Ser.no.       1111111
Ver.no.       r0.1.04.01
ID            860054081
    
```

Calibration: External

```

W-ID .....
Temperature   30.710'C
Set           +200.0000g
Diff.         + 0.0047g
Calibration Test Done
    
```

```

-----
14-Jul-10      00:03AM
Name: .....
    
```

When GLP OFF

```

Calibration:      External
W-ID .....
Temperature       30.710'C
Set               +200.0000g
Diff.             + 0.0047g
Calibration Test Done
    
```

4.4 Calibration Test with Actual Calibration

Calibration (adjusting)

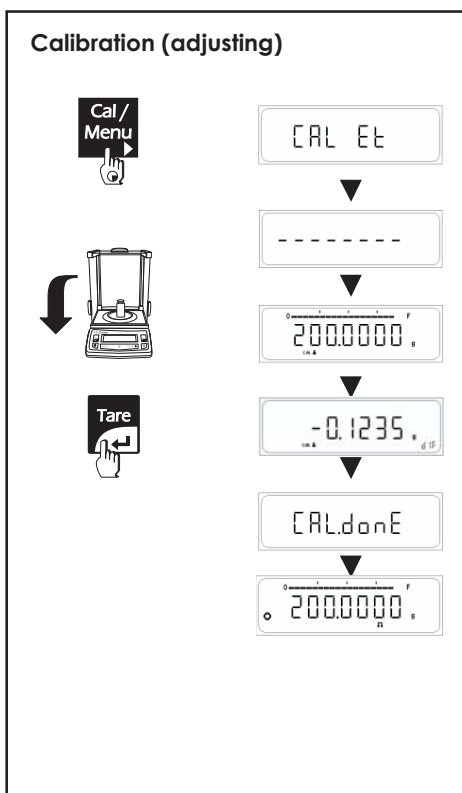

To correct the weighing results, the TARE key need to be pressed when the difference is display upon pressing the TARE key. Actual calibration is performed 'CAL done' is displayed and the weighing results are corrected as shown alongside.

Procedure

- ⇒ Have required calibration weight ready
- ⇒ Press and hold <CAL> key, display, shows "CAL Et"
- ⇒ Release <CAL> key now.
- ⇒ The required calibration weight is shown on the display.
- ⇒ Place calibration weight in center of pan.
- ⇒ The difference between the actual & the measured weight will be displayed.
- ⇒ Press the Tare key when the difference is displayed.
- ⇒ Actual Calibration is perform and Cal done is displayed.

The adjustment can be terminated at any time using the <CANCEL> key. The following message appears : 'Abort'

Calibration Test Report

If Balance is connected externally to PC or Printer via Rs232 Cable, successful or unsuccessful calibration report will be automatically generated after the completion of Calibration process.

When GLP ON

```

-----
14-Jul-10      Citizen      03:46PM
Model          CX220
Ser.no.        9930508
Ver.no.        R0.1.04
ID             1234567
-----
Calibration:   External
W-ID          .....
Temperature    32.898'C
Set            + 200.0000g
Diff.         -0.1235g
External Cal Done
Diff.          0.0000g
-----
14-Jul-09      03:46PM
Name:         .....
    
```

When GLP OFF

```

Calibration    :      External
W-ID          .....
Temperature    32.905'C
Set            + 200.0000g
Diff.         -0.1235g
External Cal Done
Diff.          0.0000g
    
```

Key Functionality in User Menu

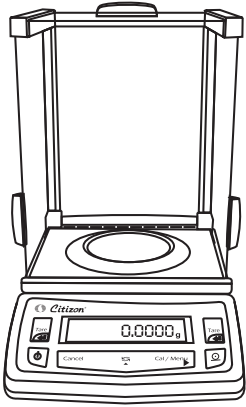

The following section explains key functionality in User Menu mode.

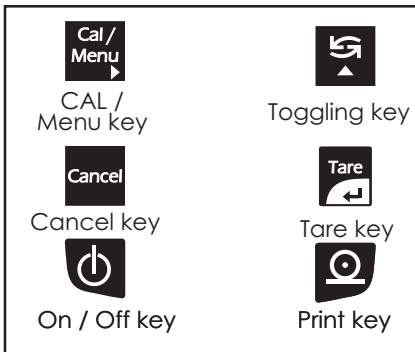

Menu (called up with)	
Press briefly	Press & Hold
On / Off	
Change Sub Menu Setting	
Increments the value of digit	
Change Main menu options	
Shifts the digit from left to right	
Confirm Setting	Store and quit menu
Print User Menu	
Quit User Menu	

5 Overview of Menu

In this menu, you can select unit 1, 2, 3 or Application Program, adjust the stability filter, Calibration choice, Auto Zero Tracking, automatic shutdown and print setting.

Weighing Mode

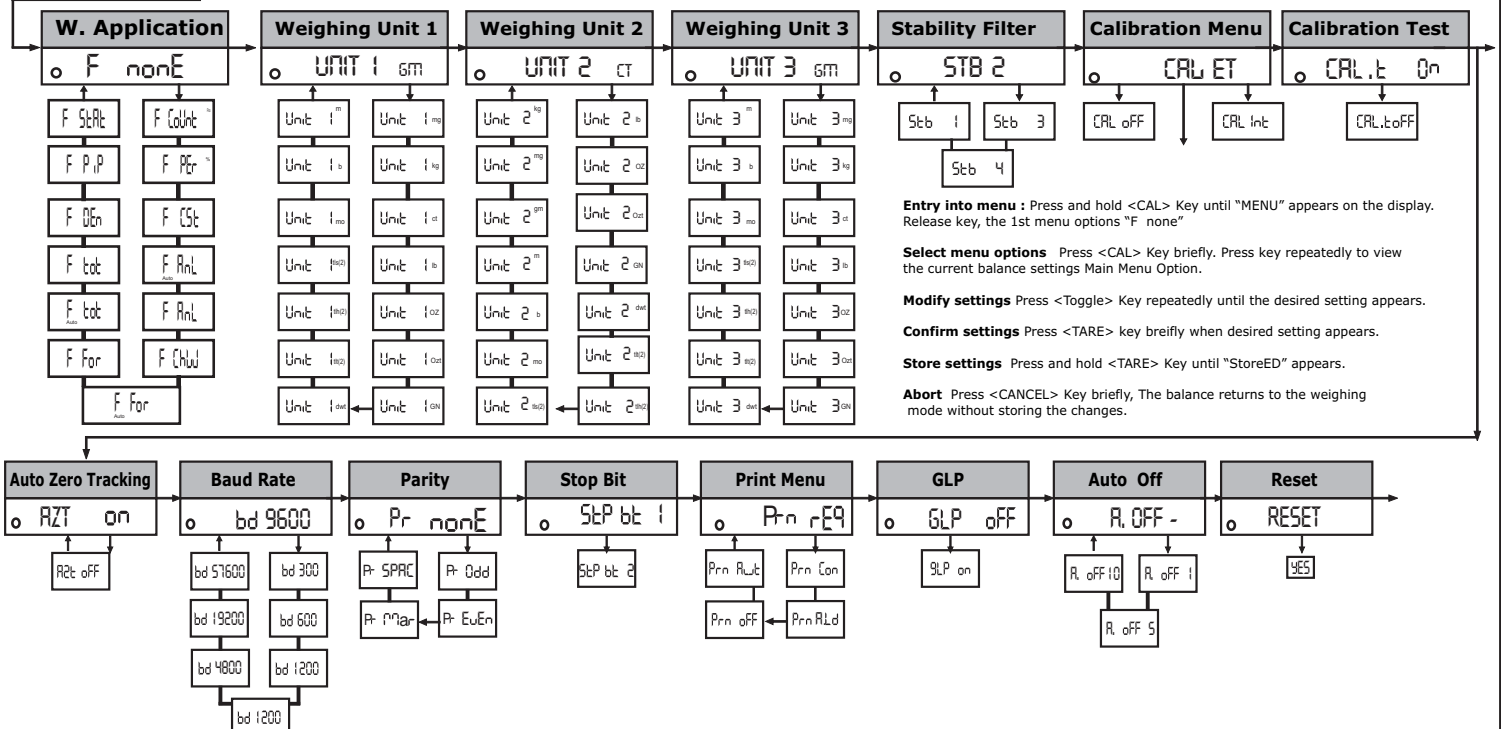

5.1 Operating Instruction

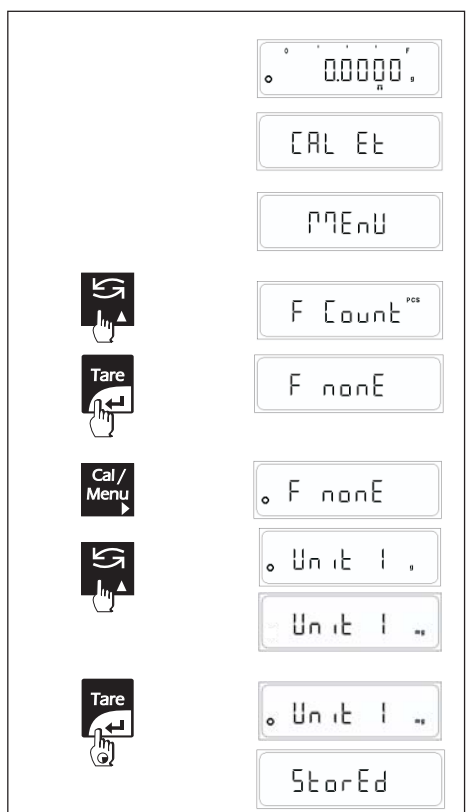

- ⇒ Press & hold CAL Key until "Menu" appears on the display.
- ⇒ Release the CAL Key
- ⇒ Existing preselected function is displayed from among the above mentioned 4 functions. This existing function is displayed with the stability indicator ON
- ⇒ Press Toggle Key to Toggle to the desired functions.
- ⇒ Press Tare Key briefly, once the desired function is displayed. Stability indicator will be ON for that particular function now.
- ⇒ Then Press & hold TARE Key once again till "STORED" is displayed on the display.
- ⇒ If more than one change is to be made within the Menu, make all the desired changes by pressing toggle key to toggle within the SUB-Menus & Pressing Tare key briefly. Stability indicator will be ON for those changed Submenu Options. Then finally, pressing & holding TARE key until "Stored" is displayed, will store all the changes made within different menu options.

Note : If user did not press & hold <TARE> key & "Stored" message appears on the display then any change made by user will remain unchanged.

Above instructions are to be followed for all menu options except : "Reset"

5.2 Description of Menu

Application Menu :

5.2.1 Special applications and functions

Your balance can do more than just weighing. Built-in applications and functions expand its possibilities and facilitate your daily work. You will learn these applications and functions in the following Sections.

Preselecting a function

In this menu option you can preselect a function which will then be available in the weighing mode (Unit 3) at a keystroke. The following functions are available.

Piece counting

Your balance counts the pieces you add to or remove from the weighing container.

Percent weighing

Your balance allows you to weigh in to a preset value or determines percentage weight deviations.

Custom Unit : Your Balance allows you to weigh in any customized unit.

Animal Weighing : Your Balance allows you to weigh animals in motion. You have the option of Auto and Manual Animal Weighing.

Checkweighing : Your balance allows you to check whether a sample corresponds to a preset target or is within a specific tolerance range.

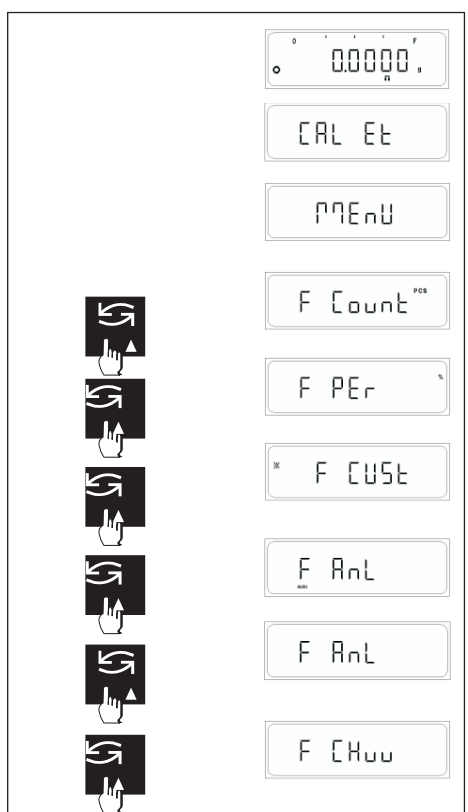

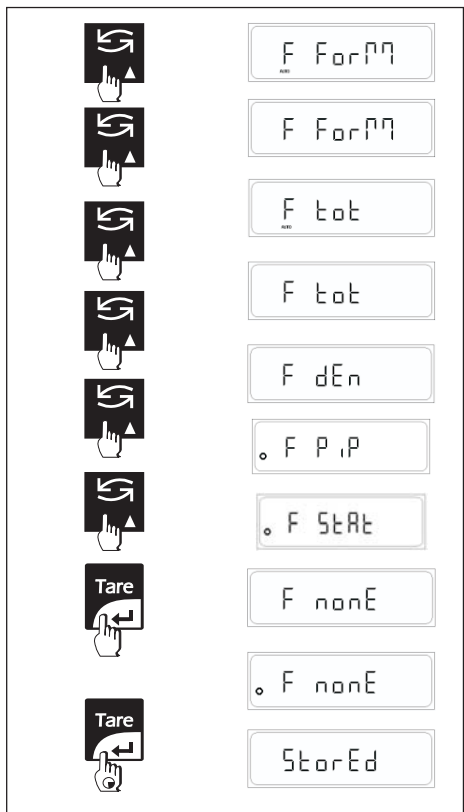

Formulation : Your Balance allow individual weighing values to be summed to a total.

Totalization : Your balance allows you to weigh, individual weighing in piece which can be summed to a total.

Density Determination : Your balance allows you to determine density of solids. Purity of gold can also be determined on the basis of density.

Pipette Calibration : Your balance allows you to calibrate the pipette used in laboratories for experimenting with liquids.

Statistics : Your balance allows you to obtain the statistics of the weighing data.

No function preselected

You have no function available in the weighing mode (**factory setting**).

Note :

Above function will replace preset unit 3 automatically.

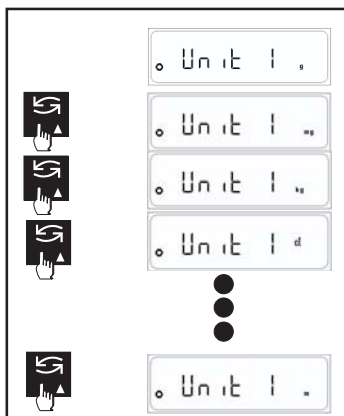

5.2.2 Unit 1, 2, 3 - selecting

The following weight units can be selected. With **certified balance** the unit selection can be blocked following installation if required by national legislation.

Unit		Conversion factor
g	gram	1
kg	kilogram	1 kg = 1000g
lb	pound	1 lb = 453.59237g
oz	ounce	1 oz = 28.349523125g
ozt	troy ounce	1 ozt = 31.1034768g
GN	grain	1 GN = 0.06479891 g
dwt	pennyweight	1 dwt = 1.555173843g
ct	carat	1 ct = 0.2g
mg	Milligram	1 mg = 0.001g
mo	momme	1 mo = 3.749999953 g
m	mesghal	1 m = 4.6083162
H tl	Hong Kong tael	1 Htl = 37,42900 g
S tl	Singapore tael	1 S tl = 37.799366256g
t tl	Taiwan tael	1 t tl = 37.499995313g
b	baht	1 b = 15.1999998438g

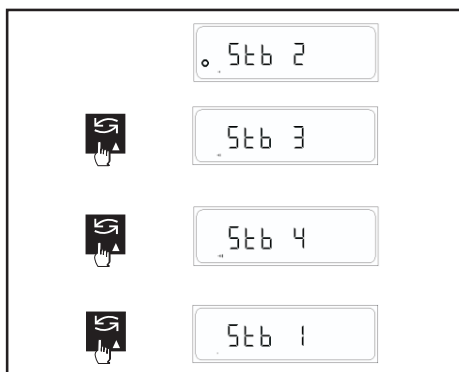

5.2.3 Adjusting the stability Filter

You can use the stability Filter to match the balance to the ambient conditions.

- 2 Setting with normal balance surroundings (factory setting)
- 3 Setting with unstable balance surroundings. The balance operates slower but is less sensitive to external influences (vibrations, etc.)
- 4 Setting with extreme unstable balance surroundings. The balance operates even slower but is less sensitive to external influences (vibrations, etc.)
- 1 Setting with very stable balance surroundings. The balance operates very quickly but is sensitive to external influences (vibrations, etc.)

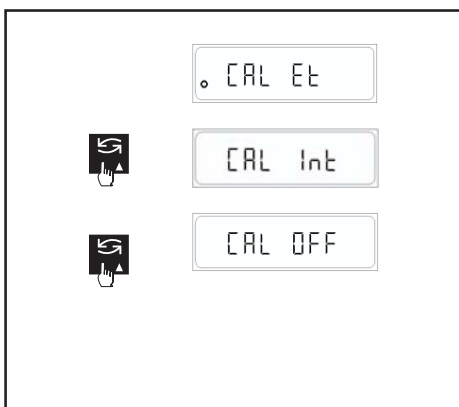

5.2.4 Selecting Calibration Option

User can select any of the Two option for Calibration.

CAL ET If the user select this option then the machine will perform External Calibration when the CAL key is press & hold to display "CAL Et" & at this moment if user release the key, user can enter into the External calibration.

CAL OFF When user press & hold CAL key, directly "Menu" appears on the display without CAL Et option. Thus user cannot enter into the calibration process.

CAL INT If the user select this option then the machine will perform External Calibration when the CAL key is press & hold to display "CAL Int" & at this moment if user release the key, user can enter into the Internal calibration.

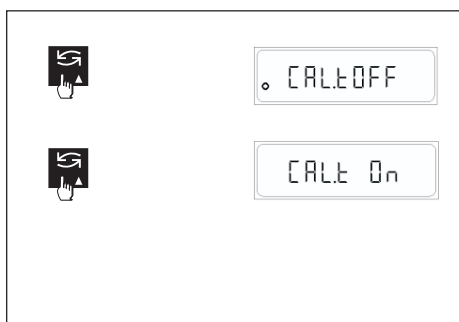

5.2.5 Calibration Test

User Can select any Two calibration test option.

CAL T ON If the user select this option then the machine will perform Calibration Test when the CAL key is press & hold Calibration Test will perform on Internal or External which ever is selected in calibration menu.

CAL T OFF Actual Calibration will be performed When the CAL key is press & hold .

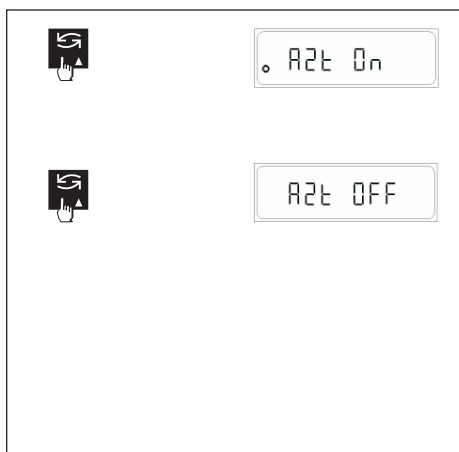

5.2.6 Auto Zero Tracking

In this option, user can select whether to enable or disable Auto Zero Tracking (Factory setting is ON)

The auto zero tracking continuously corrects any deviation from the zero point for example which can be caused due to slight contamination (i.e. due to dust particles) on the weighing pan.

Print Menu

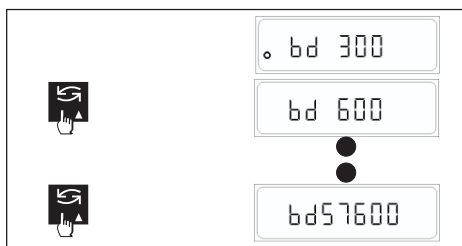

5.2.7 Setting baud rate (data transmission rate)

The data transmission rate (baud rate) determines the speed of the transmission via the serial interface.

The unit is baud (1 baud (bd) = 1 bit/second).

The following setting are available. bd 300, bd 600, bd 1200, bd 2400, bd 4800, bd 9600 (default), bd 19200, bd 57600

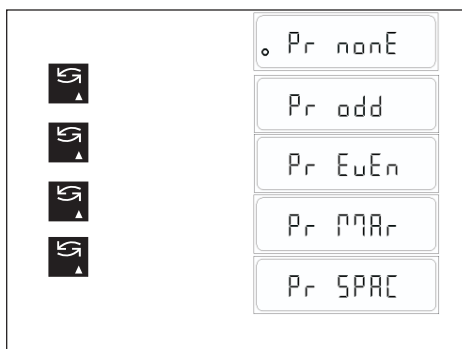

5.2.8 Setting Parity

This feature determines the parity of the transmitted data. The following settings are available: Parity, None (default), odd, even, mark, space.



5.2.9 Stop Bit Selection

This setting allows the user to select the stop bit for the transmitted data.

The following settings are available: stop bit 1 (Default) and stop bit 2.

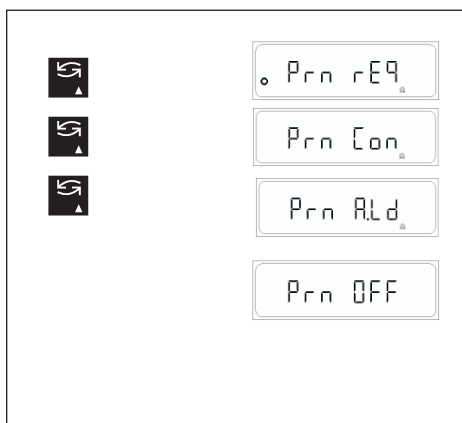

5.2.10 Selecting data transfer mode

In this menu block you tell the balance how a value should be transferred to a peripheral device (e.g. computer).

- Prn. req The next possible stable value will be transferred after triggering of the Print key.
- Prn. Con All Values will be continuously transferred regardless of stability.
- Prn. oFF Data Transfer mode switched off
- Prn. Aut Next Possible stable value will be transfer automatically when the display weight changes by + 1d.
- Prn A.Ld Next possible stable value will be transferred automatically when the display weight changes by +/- 10d

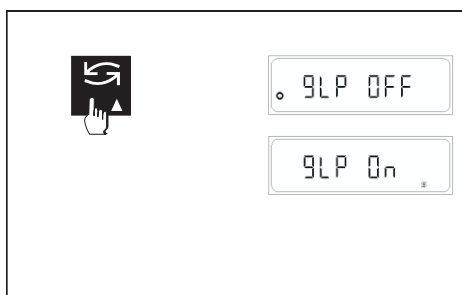

5.2.11 GLP Menu Setting

- GLP oFF If the user select this option then the balance print format are not compliance to ISO/GLP/GMP.
- GLP on If the user select this option then the balance print format are compliance to ISO/GLP/GMP.

Note

If user selected GLP ON do ensure that user print footer for entering into next transaction and enter into user Menu or Calibration.

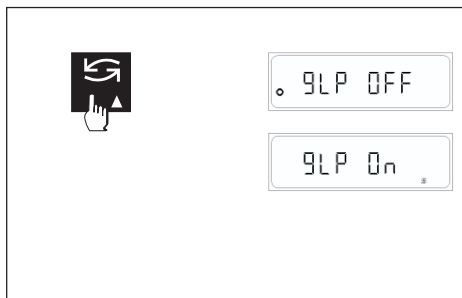

5.2.12 GLP Menu Setting

GLP off : If the user select this option then the balance print format are not compliance to ISO/GLP/GMP.

GLP on : If the user select this option then the balance print format are compliance to ISO/GLP/GMP.

Note

If user selected GLP ON do ensure that user print footer for entering into next transaction and enter into user Menu or Calibration.

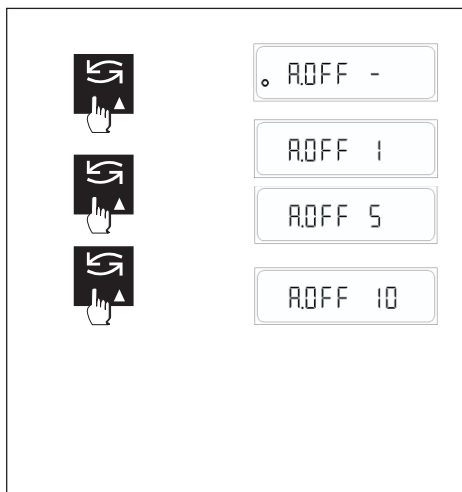

5.2.13 A. Off - Setting automatic standby

The automatic standby appreciably extends the operating life of your Battery (If Install) (Optional)

The balance will enter stand by mode if A-OFF is activated.

The display on the balance remains zero for a specific time as selected in the A.OFF menu.

- A. Off - : no automatic standby (factory setting)
- A. Off 1 : automatic standby after 1 minutes
- A. Off 5 : automatic standby after 5 minutes
- A. Off 10 : automatic standby after 10 minutes

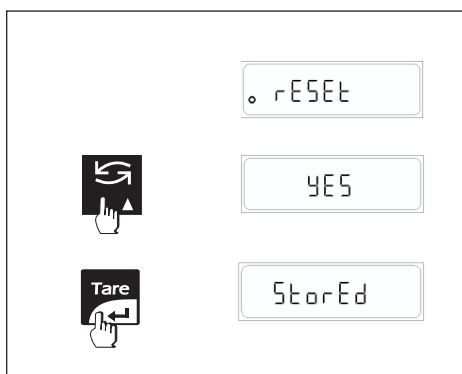

5.2.14 Reset of the balance setting

Reset balance setting and functions to factory setting (rESEt)

- ⇒ Select "rESEt" and Press <TOGGLE> key briefly, display show "YES"
- ⇒ Press <TARE> key briefly, display show "stored"

The balance is now reset to the factory setting and returns to the weighing mode._

Factory Setting

F none	No Function
Unit 1	gm
Unit 2	ct
Unit 3	gm
Stb 2	balance environment set to Normal
CAL Et	CAL External
CAL t	CAL TEST OFF
Azt ON	Auto Zero Tracking set ON
bd9600	Transmission rate
Pr None	Parity set to none
Stpbt 1	Stop bit one
Print	Req
GLP	OFF
A. oFF	- no automatic standby

USER MENU PRINT OUT

Press the Print Key in the user Menu to Print the current status of user menu.

When GLP ON		When GLP OFF	

14-Jul-10	03:46PM		
	Citizen		
Model	Cy 220	App	: F Per
Ser.no.	9930508	Unit1	: g
Ver.no.	R0.1.04	Unit2	: ct
ID	1234567	Unit3	: g
-----		Stb	: 2
App	: F Per	Cal	: Ext
Unit1	: g	Cal test	: Off
Unit2	: ct	Azt	: On
Unit3	: g	Baudrate	: 9600
Stb	: 2	Parity	: None
Cal	: Ext	Stop bit	: 1
Cal test	: Off	Print	: Request
Azt	: On	GLP	: On
Baudrate	: 9600	Auto Off	: Off
Parity	: None		
Stop bit	: 1		
Print	: Request		
GLP	: On		
Auto Off	: Off		

14-Jul-10	03:46PM		
Name:		

6. Functions

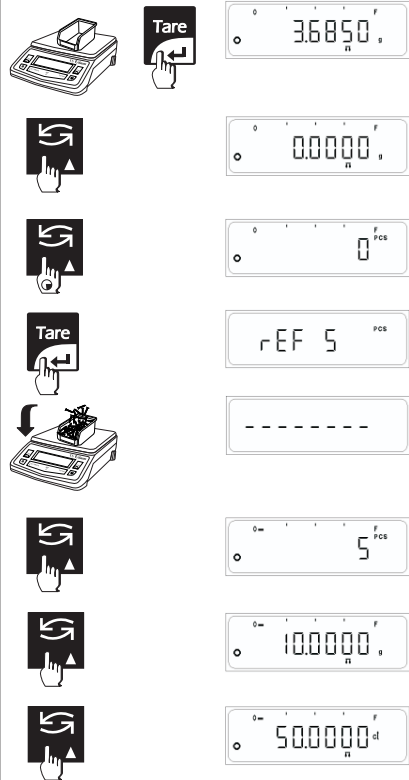

6.1 Piece counting

Procedure

Piece counting presupposes that you have preselected the "F count" function in the menu

- ⇒ Place the empty container on the pan.
- ⇒ Press the <TARE> key briefly to tare the balance.
- ⇒ Press the <TOGGLE> key briefly until "PCS" appears on the display. Your balance now needs the weight of a reference number.
- ⇒ Press and hold the <TOGGLE> key until you are prompted to load the reference pieces.
- ⇒ Your balance suggests the last set reference no. as the reference number. You can accept this suggestion or select one of the other reference numbers available (5, 10, 20,50, 100 pieces, Free, wref, Update) by briefly pressing the <TOGGLE> key.

Note : We recommend you to choose a reference number as high as possible as the balance determines the average weight per piece and stores it as the reference weight. As it is seldom, that all pieces weigh exactly the same, the larger the reference number selected, the greater the accuracy of the reference weight. This application assumes uniform weight of each piece.

- ⇒ When you have placed exactly the same number of pieces on the weighing pan as selected reference pieces press TARE key. As soon as the weighing result is stable, the calculated average piece weight is accepted as the reference.
- ⇒ After your balance has determined the piece weight, it displays the pieces as per selected number and is now ready for piece counting. You can use the <TOGGLE> key at any time to switch the display between the piece number display, weighing unit 1 and weighing unit 2.

Note : The current set weight remains stored until it has been redetermined.

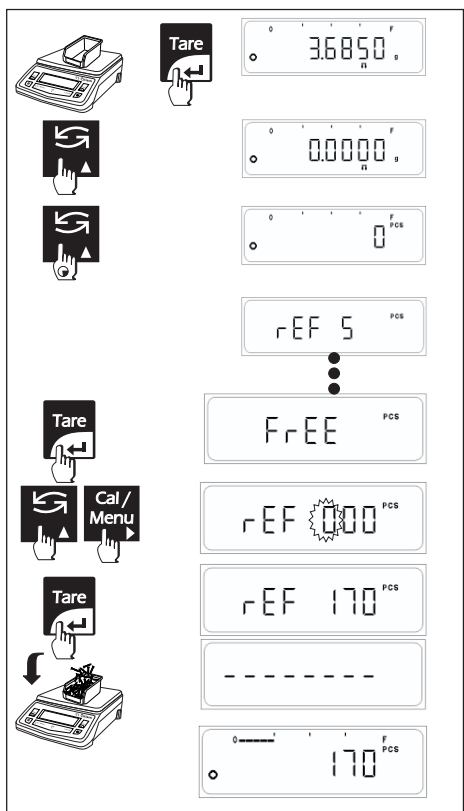

6.1.1 FREE (Reference settings)

The FREE option allows the user to set any reference other than the fixed available reference.
(Default value is 001 and maximum possible value is 999)

Procedure

- ⇒ Place the empty container on the pan.
- ⇒ Press the <TARE> key briefly to tare the balance.
- ⇒ Press the <TOGGLE> key briefly until "pcs" appears on the display.
Your balance now needs the weight of a reference number.
- ⇒ Press and hold the <TOGGLE> key until you are prompted to load the reference pieces.
- ⇒ Your balance suggests the last set reference no. as the reference number.
- ⇒ Press the <TOGGLE> key until FREE is displayed.
- ⇒ Press the <TARE> key to enter FREE reference settings.
- ⇒ Last stored FREE value first digit flashing. Flashing digit indicates that digit value or place can be changed.
- ⇒ Press <TOGGLE> key (▲) to change the value of the Flashing digit.
- ⇒ Press <CAL> key (▶) to shift the flashing digit from Left to Right
- ⇒ When you have placed exactly the same number of pieces on the weighing pan as set in the FREE setting, press TARE key.

As soon as the weighing result is stable, the calculated average piece weight is accepted as the reference

Now further weighing in PCS will be with respect to the reference calculation based upon the FREE setting.

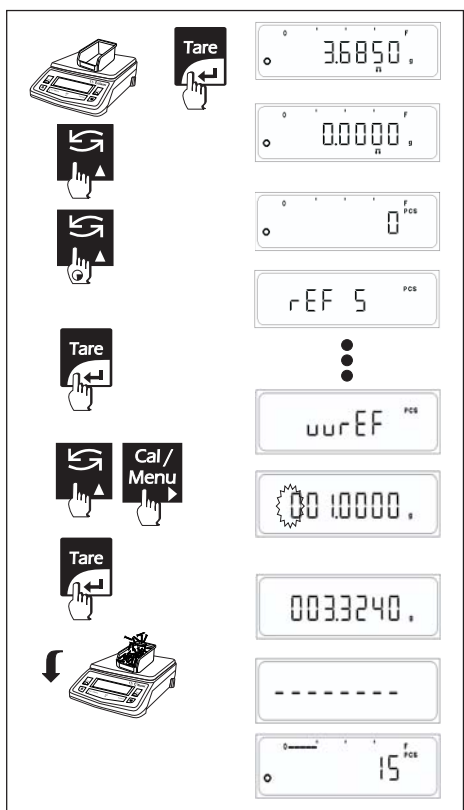

6.1.2 wRef settings

If the piece weight is known, it can be entered directly. To do this, press the TARE key when the system displays **wRef** in the reference menu. An input field appears, in which the piece weight can be entered.

Since the balance does not have to determine a reference by weighing, the result of the piece counting (the number of pieces currently on the weighing pan) is displayed right after the piece weight has been confirmed.

Procedure

- ⇒ Place the empty container on the pan.
- ⇒ Press the <TARE> key briefly to tare the balance.
- ⇒ Press the <TOGGLE> key briefly until "pcs" appears on the display.
Your balance now needs the weight of a reference number.
- ⇒ Press and hold the <TOGGLE> key until you are prompted to load the reference pieces.
- ⇒ Your balance suggests the last set reference no. as the reference number.
- ⇒ Press the <TOGGLE> key until wRef is displayed.
- ⇒ Press the <TARE> key to enter wRef reference settings.
- ⇒ Last stored wRef value first digit flashing. Flashing digit indicates that digit value or place can be changed.
- ⇒ Press <TOGGLE> key (▲) to change the value of the Flashing digit.
- ⇒ Press <CAL> key (▶) to shift the flashing digit from Left to Right
- ⇒ Press tge <TARE> key to store the wRef value.

Now further weighing in PCS will be with respect to the wRef value.

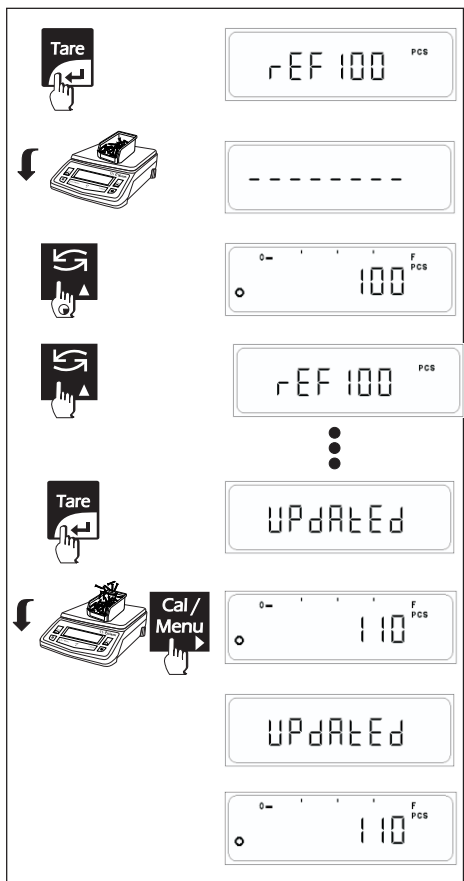

6.1.3 Updating Settings

The Update feature improves the precision of piece counting results. The average piece weight (reference) is recalculated with each reference optimization. Because the new pieces that have been placed in the weighing pan increase the basis for the calculation, the references, and therefore the result of the piece count, are more exact.

Select the UPDATE feature from the reference menu. The reference can be updated by pressing the CAL key which is confirmed by the displaying 'UPDATED' on the display.

Note

- The number of pieces placed in the weighing pan is larger than the reference piece number shown on the display.
- The number of pieces placed in the weighing pan is not greater than twice the most recently saved reference piece number (e.g. If the display shows 100 pcs the added pieces should not be greater than 200).
- Update feature cannot be selected if the previous selected reference was 'wRef'

If the balance is connected externally to PC or Printer through RS 232 C then, whenever user enter into the reference menu of Piece Counting function & make changes in the reference setting, automatically printout is generated on the Peripheral attached.

In the printout, reference number "nRef" and reference weight "wRef" is printed. After this user can Press Print Key to Print the reading on the display. Also user can Toggle to other unit through Toggle key & Press Print Key to get the print out of those corresponding units.

When GLP ON

Printouts generated when Unit Toggling is done between Application Unit (Pcs), Unit1 and Unit2 and Reference Weight is changed

```

-----
29-Jul-09      03:46PM
      Citizen
Model         CX 220
Ser.no.       9930508
Ver.no.       r0.1.04
ID            1234567
-----
LID:          1000000
NRef          5 pcs
WRef          4.00 g
Qnt +         5 pcs
NRef          50 pcs
WRef          0.40 g
Qnt +         50 pcs
Qnt +         25 pcs
NRef          5 pcs
WRef          2.00 g
Qnt +         5 pcs
  
```

```

-----
29-Jul-09      03:47PM
Name:         .....
-----
  
```

When GLP OFF

Printouts generated when Unit Toggling is done between Application Unit (Pcs), Unit1 and Unit2 and Reference Weight is changed

```

nRef          5 pcs
wRef          2.00 g
Qnt +         5 pcs
Qnt +         10 pcs
nRef          10 pcs
wRef          2.00 g
Qnt +         10 pcs
Qnt +         5 pcs
nRef          50 pcs
wRef          0.20 g
Qnt +         50 pcs
Qnt +         100 pcs
  
```

Printout: Counting

nRef	+	10	:	Reference sample quantity
wRef	+	21.14 g	:	Reference weight i.e. weight of one piece
Qnt	+	500 pcs	:	Calculated quantity

- Note :** 1) User cannot enter into the external calibration or menu when GLP is ON & footer has not been printed.
2) To print footer user will have to Press <CANCEL> key.

6.2 Percent Weighing (%)

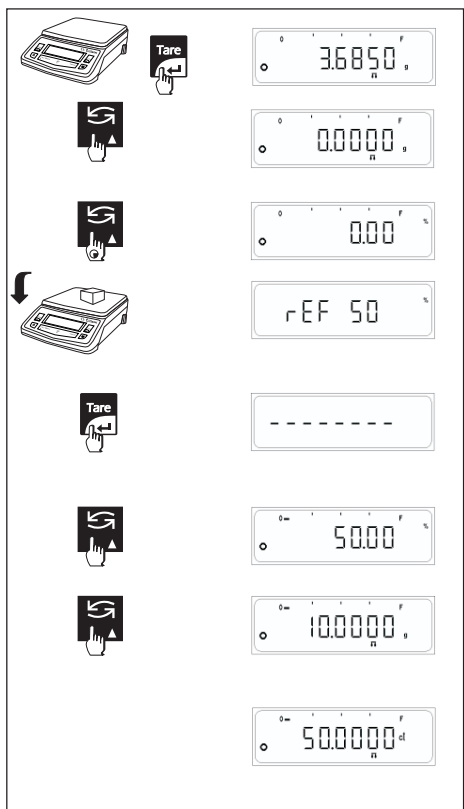

The "Percent weighing" function enables you to weigh in to a preset value (1, 10, 20, 50, 100%, Free, 100r, 100L, AtroM, AtroD) and to determine deviations from this target value.

Percent Weighing (%) presupposes that you have preselected the "F per" function in the menu

Procedure

- ⇒ Place the empty container on the pan.
- ⇒ Press the <TARE> key to tare the balance.
- ⇒ Press the <TOGGLE> key briefly until "PER (%)" appears on the display. Your balance now needs the weight of a reference percent (%).
- ⇒ Press and hold the <TOGGLE> key until you are prompted to load the reference PER (%).
- ⇒ Your balance suggests the last set reference % as the reference percent (%) You can accept this suggestion or select one of the other reference percent (%) available (1, 10, 20, 50, 100 %, Free, 100r, 100L, AtroM, AtroD) by briefly pressing the <TOGGLE> key.
- ⇒ Default is **1%**

The FREE option allows the user to set any reference other than the standard available reference. (Default value is 01.00 % and maximum possible value is 99.99%)

- ⇒ Now place reference sample on the pan.
- ⇒ Then press <TARE> key. Until dashes are displayed, your balance is calculating the reference
- ⇒ After your balance has determined the reference weight, it is ready for Percent Weighing.

You can use the <TOGGLE> key at any time to switch the display between the Percent (%) display, weighing unit 1 and weighing unit 2.

Note : The current set weight remains stored until it has been redetermined.

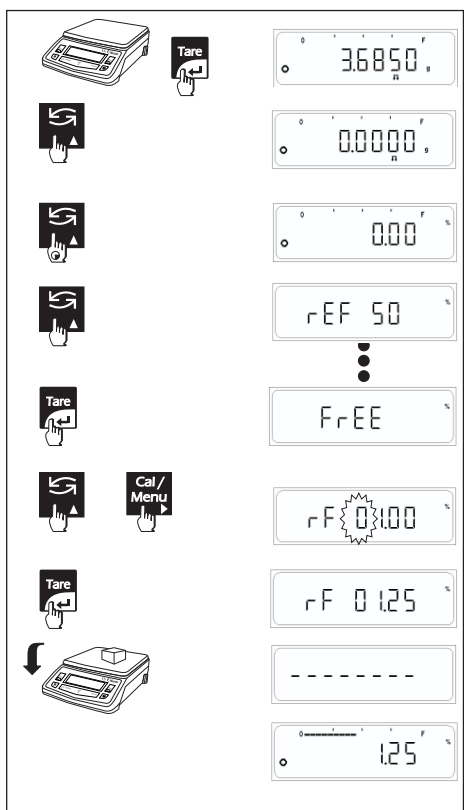

6.2.1 FREE (Reference settings)

The FREE option allows the user to set any reference other than the standard available reference.

(Default value is 1.00% and maximum possible value is 99.99%)

Procedure

- ⇒ Place the empty container on the pan.
- ⇒ Press the <TARE> key briefly to tare the balance.
- ⇒ Press the <TOGGLE> key briefly until "PER" appears on the display. Your balance now needs the weight of a reference number.
- ⇒ Press and hold the <TOGGLE> key until you are prompted to load the reference pieces.
- ⇒ Your balance suggests the last set reference no. as the reference number.
- ⇒ Press the <TOGGLE> key until FREE is displayed.
- ⇒ Press the <TARE> key to enter FREE reference settings.
- ⇒ Last stored FREE value is displayed. Flashing digit indicates that digit value or place can be changed.
- ⇒ Press <TOGGLE> key (▲) to change the value of the Flashing digit.
- ⇒ Press <CAL> key (▶) to shift the flashing digit from Left to Right
- ⇒ When you have placed exactly the same number of pieces on the weighing pan as set in the FREE setting, press TARE key.

As soon as the weighing result is stable, the calculated average piece weight is accepted as the reference

If the balance is connected externally to PC or Printer through RS 232 C then, whenever user enter into the reference menu of Percent Weighing function & make changes in the reference setting, automatically printout is generated on the Peripheral attached. In the printout, reference percent "pRef" and reference weight "wRef" is printed. After this user can Press Print Key to Print the reading on the display.

Also user can Toggle to other unit through Toggle key & Press Print Key to get the print out of those corresponding units.

When GLP ON

Printouts generated when Unit Toggling is done between Application Unit (%), Unit1 and Unit2 and Reference Weight is changed

```

-----
29-Jul-10      03:46PM
      Citizen
Model         CX 220
Ser.no.       9930508
Ver.no.       R0.1.04
ID            1234567
-----
LID:          1000000
Ref           10.00 %
wRef          1.00 g
Pct +         10.00 %
+            10.0000 g
+            50.0000 ct
Pct +         20.00 %
pRef          1.00 %
wRef          20.00 g
Pct +         1.00 %
Pct +         0.50 %
-----
29-Jul-10      03:47PM
Name:         .....
-----

```

When GLP OFF

Printouts generated when Unit Toggling is done between Application Unit (%), Unit1 and Unit2 and Reference Weight is changed

```

Ref           10.00 %
wRef          1.00 g
Pct +         10.00 %
+            10.0000 g
+            50.0000 ct
Pct +         20.00 %
pRef          1.00 %
wRef          20.00 g
Pct +         1.00 %
Pct +         0.50 %

```

Printout: Counting

```

pRef          10%      : Reference percentage
wRef +        21.14 g : Reference weight
Pct +         90.34%  : Calculated percentage

```

- Note :** 1) User cannot enter into the external calibration or menu when GLP is ON & footer has not been printed.
 2) To print footer user will have to Press <CANCEL> key.

6.2.2 Differential Weighing

The Differential Weighing application is used to analyze changes in the weight of one or more samples. The first step is to determine the initial weight of the sample (weighing in). Selected components are then separated from or added to the sample. This includes procedures such as drying, centrifugation, filtering, incineration, vaporization, coating, etc. After the sample has been processed, it is re-weighed (residual weight). The balance then determines the difference between the two weighed values.

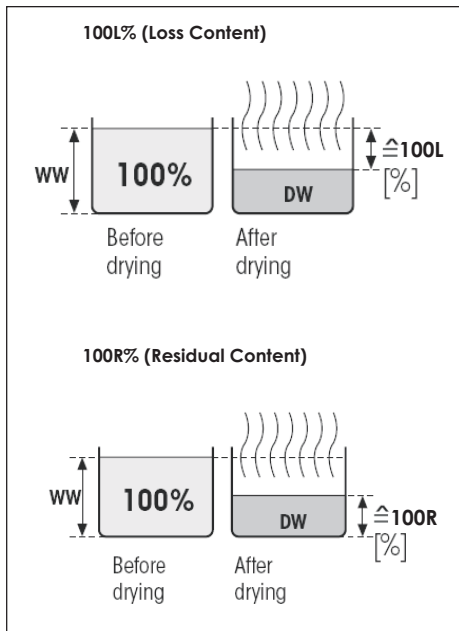

100L (Loss)

The moisture content of the sample is displayed (and printed out) as a percentage of the wet weight (= ww = initial weight = 100%). When the results are printed out, the moisture content is designated "100L %" (**Loss**) (e.g. -11.35 100.00L%) and shown as a negative value.

$$100L [0...-100\%] = \frac{\text{Dry weight } DW - \text{Wet weight } WW}{\text{Wet weight } WW} * 100\%$$

100R (Residue)

The dry content of the sample is displayed (and printed out) as a percentage of the wet weight (= ww = initial weight = 100%). When the results are printed out, the dry content is designated "100R%" (**Residue**) (e.g. 88.65 100.00R%).

$$100R [100...0\%] = \frac{\text{Dry weight } DW}{\text{Wet weight } WW} * 100\%$$

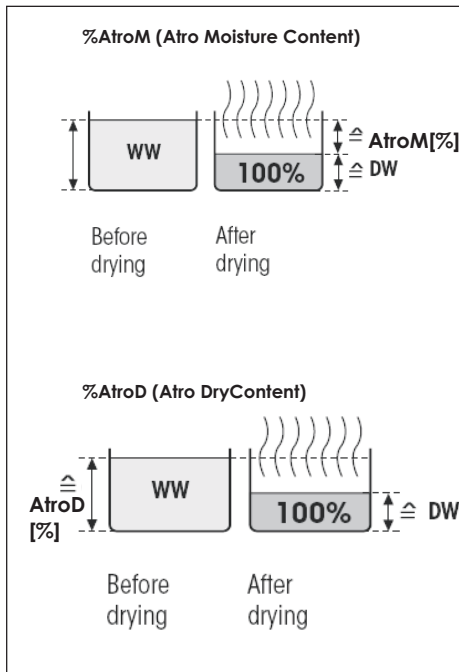

AtroM Moisture Content

The moisture content of the sample is displayed (and printed out) as a percentage of the dry weight (= DW = final weight = 100%). When the results are printed out, the ATRO moisture content is designated "AtroM %" (**ATRO Moisture Content**) (e.g. -255.33 AtroM %) and shown as a negative value.

$$\text{AtroM} [0...-1000\%] = \frac{\text{Dry weight } DW - \text{Wet weight } WW}{\text{Dry weight } DW} * 100\%$$

AtroD Dry Content (Wet weight)

The wet weight of the sample is displayed (and printed out) as a percentage of the dry weight (= DW = final weight = 100%). When the results are printed out, the ATRO dry content is designated "AtroD %" (**ATRO Dry Content**) (e.g. 312.56 AtroD %).

$$\text{AtroD} [100...1000\%] = \frac{\text{Wet weight } WW}{\text{Dry weight } DW} * 100\%$$

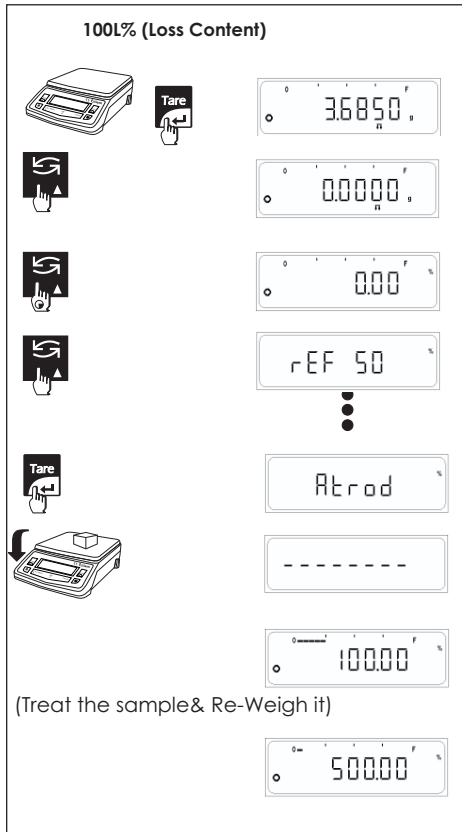

Percentage Weighing (%) (in 100R / 100L / AtroM / AtroD)

Percent Weighing (%) presupposes that you have preselected the "F per" function in the menu

Procedure

- ⇒ Press the <TARE> key to tare the balance.
- ⇒ Press the <TOGGLE> key briefly until "PER (%)" appears on the display. Your balance now needs the weight of a reference percent (%).
- ⇒ Press and hold the <TOGGLE> key until you are prompted to load the reference PER (%).
- ⇒ Your balance suggests the last set reference % as the reference percent (%). Press the <TOGGLE> key until the following option is displayed (100R / 100L / AtroM / AtroD)
- ⇒ Now place reference sample on the pan which is to be analyzed (Initial Weight).
- ⇒ Then press <TARE> key. Until horizontal dashes are displayed, your balance is calculating the reference.
- ⇒ After your balance has determined the reference weight, it is ready for Percent Weighing in Differential weighing.
- ⇒ Now treat the sample which includes process like drying, centrifugation, filtering, incineration, vaporization, coating, etc. After the sample has been processed, re-weigh it (residual weight). The balance then determines the difference between the two weighed values.

You can use the <TOGGLE> key at any time to switch the display between the Percent (%) display, weighing unit 1 and weighing unit 2.

Note: If the current measured value on display mode is greater or less than the predefined limit value (i.e. greater than 999.99 % or less than -999.99 %) the balance displays Over range **(----Or----)**

If the balance is connected externally to PC or Printer through RS 232 C then, whenever user enter into the reference menu of Percent Weighing function & make changes in the reference setting, automatically printout is generated on the Peripheral attached. In the printout, reference percent "pRef" and reference weight "wRef" is printed. After this user can Press Print Key to Print the reading on the display. Also user can Toggle to other unit through Toggle key & Press Print Key to get the print out of those corresponding units.

When GLP ON

Printouts generated when Unit Toggling is done between Application Unit (**Per %**), Unit1 and Unit2 and Reference Weight is changed

```

-----
28-Jul-10      03:19PM
      Citizen
Mode1          CX 220
Ser.no.        9223102
Ver.no.        r0.1.5.3
ID             1234567
-----
LID:           1111111
pRef           ATROD %
wRef           0.5000 g
Pct +         100.00 %
Pct +         500.00 g
+             50.0000 g
+             250.0000 ct
-----
28-Jul-10      03:23PM
Name:         .....
```

When GLP OFF

Printouts generated when Unit Toggling is done between Application Unit (**Per %**), Unit1 and Unit2 and Reference Weight is changed

```

pRef           ATROD %
wRef           0.5000 g
Pct +         100.00 %
Pct +         500.00 %
+             50.0000 g
+             250.0000 ct
```

Note : 1) User cannot enter into the external calibration or menu when GLP is ON & footer has not been printed.
2) To print footer user will have to Press <CANCEL> key.

6.3 Custom Unit

The custom unit feature enables you to perform weighing in a customized unit i.e. weighing can now be performed in a unit other than standard available 15 units.

Procedure

Custom unit presupposes that you have selected the 'F Cust' in the user menu.

- ⇒ Place the empty container on the pan.
- ⇒ Press the <TARE> key briefly to tare the balance.
- ⇒ Press the <TOGGLE> key briefly until "CS†" appears on the display.
Your balance now needs conversion factor, accuracy and LSD to perform weighing in custom unit.
- ⇒ Press and hold the <TOGGLE> key to browse through the custom unit setting menu.
Your balance suggests the last stored values for the factor, accuracy and LSD.
- ⇒ Press the <TARE> key to enter the specific setting.

Factor Setting

The factor value can be set to any user defined value except for zero.

- ⇒ Press the <TARE> key to enter the factor setting.
- ⇒ Press the <TOGGLE> key (▲) to change the value of the flashing digit.
- ⇒ Press the <CAL> key (▶) to change the flashing digit from left to right.
- ⇒ Press the <PRINT> key to shift the decimal position in a cyclic way.
- ⇒ After proper setting of factor press the <TARE> key.

Note: Please refer error conditions for errors occurred in storing the Factor, Accuracy and LSD settings.

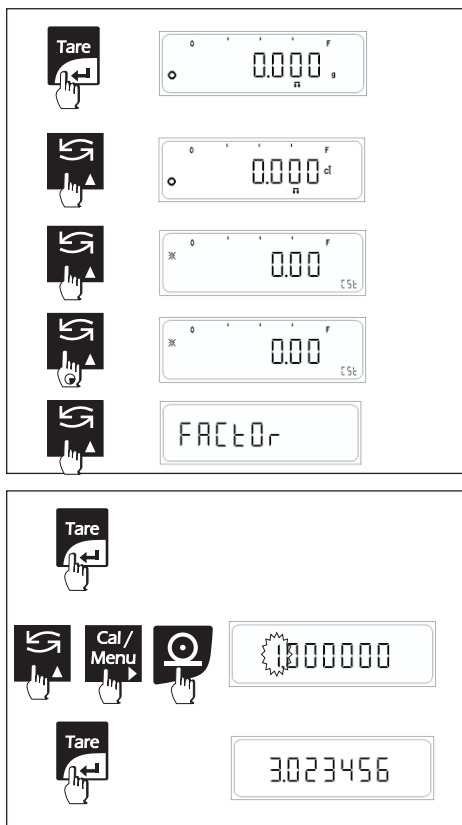

Accuracy Setting

- ⇒ Press the <TARE> key when the Acc is displayed.
- ⇒ Press the <TOGGLE> key to browse through the standard available accuracy.
- ⇒ You can select any of the standard accuracy with the help of <TARE> key.

Standard accuracies available are
0.000001, 0.00001, 0.0001, 0.001, 0.01, 0.1, 1, 10, 100, 1000

The stability indicator alongside indicates the selected accuracy.
The Accuracy Setting is for display purposes and not for calculation of Custom unit.

LSD Setting

- ⇒ Press the <TARE> key when LSD is displayed.
- ⇒ Press the <TOGGLE> key to browse through the standard available LSD's.
- ⇒ You can select any of the standard available LSD (Least significant Digit) with the help of <TARE> key.

Standard LSD's available are
1, 2, 5, 10, 20, 50, 100

The stability indicator alongside indicates the selected LSD.

To store the Factor, Accuracy and LSD values, press and hold the <TARE> key when the display shows Factor or Acc or LSD

The default settings are
Factor = 1.0000 (i.e. 1 gram)
Accuracy = 0.01
LSD = 1

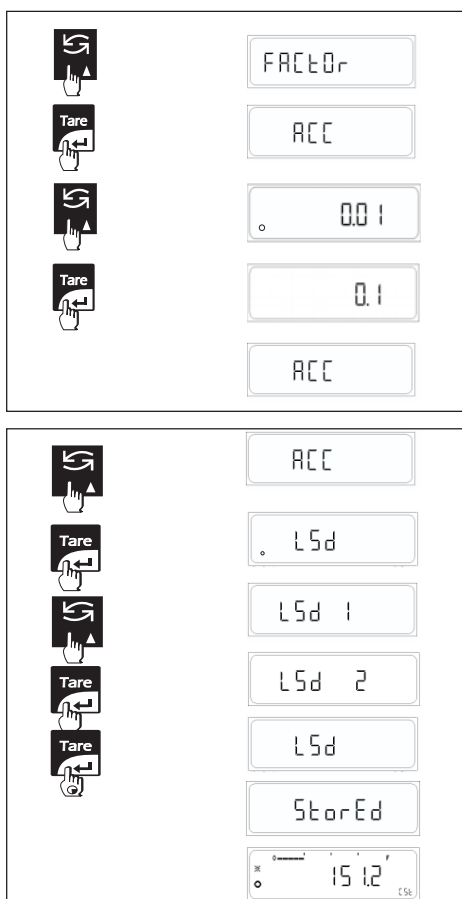

E.g. If the settings are as follows,
 Factor = 1.02356
 Accuracy = 0.00
 LSD = 50

Now if 50 gm of weight is loaded on the pan the calculation for displayed weight will be as follows,
 Weight * Factor
 = 50 * 1.023456
 = 51.1728

The displayed weight will be 51.150

The second digit after decimal point will change in multiples of 5 because,

Accuracy * LSD
 = 50 * 0.001
 = 0.05

You can use the <TOGGLE> key at any time to switch the display between custom unit display, weighing unit 1 and weighing unit 2. User can go to Standby mode by pressing on/off key and go to Simple Weighing with unit 1 by Cancel key and balance shows Current weights.

If the balance is connected eternally to PC or Printer through RS 232 C then, whenever user enter into the Custom Unit Menu & make changes in the Factor, Accuracy and LSD setting, automatically printout is generated on the Peripheral attached.

In the printout, the new Factor, Accuracy and LSD values are printed. After this user can Press Print Key to Print the reading on the display. Also user can Toggle to other unit through Toggle key & Press Print Key to get the print out of those corresponding units.

When GLP ON

When GLP OFF

Printouts generated when Unit Toggling is done between Application Unit (Cst), Unit1 and Unit2.

Printouts generated when Unit Toggling is done between Application Unit (Cst), Unit1 and Unit2.

```

-----
28-Jul-10      03:19PM
      Citizen
Model          CX 220
Ser.no.        9223102
Ver.no.        r0.1.5.3
ID             1234567
-----
LID:           1111111
Factor         3.023456
Accuracy       0.1
Lsd            2
+             151.2 cst
+             50.0000 g
+             250.000 ct
Factor         1.023456
Accuracy       0.001
Lsd            50
+             61.400 cst
+             51.200 cst
-----
  
```

```

Factor         3.023456
Accuracy       0.1
Lsd            2
+             151.2 cst
+             50.0000 g
+             250.000 ct
Factor         1.023456
Accuracy       0.001
Lsd            50
+             61.400 cst
+             51.200 cst
  
```

```

-----
28-Jul-10      03:23PM
Name:
.....
-----
  
```

- Note :** 1) User cannot enter into the external calibration or menu when GLP is ON & footer has not been printed.
 2) To print footer user will have to Press <CANCEL> key.

6.4 Animal Weighing

The animal weighing feature enables you to perform weighing of unstable samples (live animals). The balance calculates the weight as the average of a defined number of individual weighing operations.

You can select from the two available animal weighing modes i.e. Auto animal weighing and manual animal weighing.

The weighing unit for animal weighing will be the same as selected for unit 1.

For Animal Weighing Process to start two conditions should be satisfied, the weight of the animal kept on the pan should be higher than 100 display increment i.e. if the balance capacity is 300 gm and accuracy is 0.0001 gm, then in Animal Weighing Process the weight of the animal should be above $100 * 0.0001 \text{ g} = 0.001 \text{ g}$ and When two successive weight measured are within predefined tolerance range.

Number of weighing operations for calculation of an average **Cnt** can be set before the beginning of each series.

Balance returns to the basic weighing mode when unloaded; i.e., when the load is below the unload threshold

The Unload threshold is 50 display intervals.

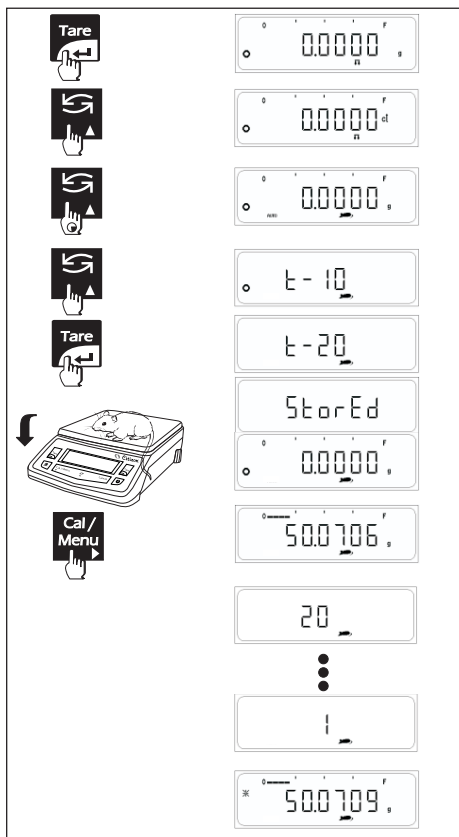

6.4.1 Manual Animal Weighing

Manual Animal Weighing presupposes that you have selected the 'F An1' in the user menu.

Procedure

- ⇒ Place the empty container on the pan.
- ⇒ Press the <TARE> key briefly to tare the balance.
- ⇒ Press the <TOGGLE> key briefly until " 🐾 " symbol appears on the display. Your balance now needs to set the countdown value.
- ⇒ Press and hold the <TOGGLE> key to enter countdown options. The entire menu can be accessed by pressing the <TOGGLE> key. The stability symbol indicates the currently selected countdown value.
- ⇒ Press the <TARE> key to select specific countdown value.
- ⇒ Keep the animal on the pan, press the <CAL> key to start the animal weighing process when both the condition required for animal weighing are met the countdown process will start, when the countdown time ends the average weight on animal is displayed with the display locked with flashing animal symbol.

Locked display is indicated by the flashing animal and AUTO symbol.

The countdown options available are,

- t-5
- t-10 (Default)
- t-20
- t-50
- t-100

You can use the <TOGGLE> key at any time to switch the display between animal weighing, weighing unit 1 and weighing unit 2. User can go to Standby mode by pressing on/off key and go to Simple Weighing with unit 1 by Cancel key and balance shows Current weights.

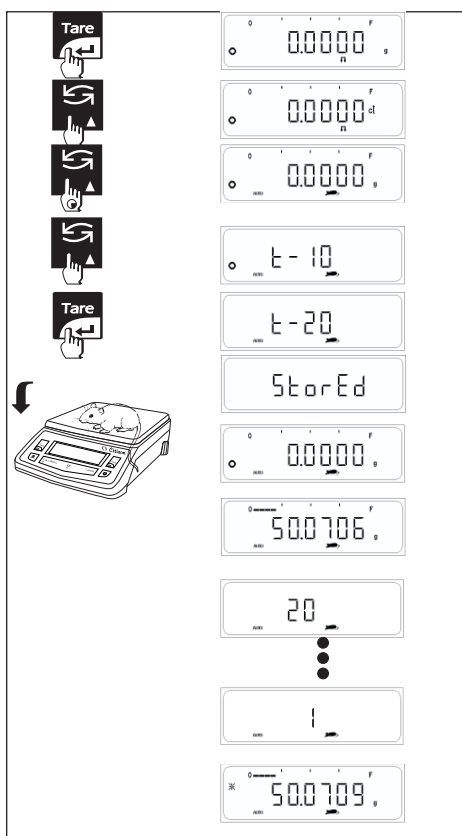

6.4.2 Auto Animal Weighing

Auto Animal Weighing presupposes that you have selected the 'F Anl AUTO' in the user menu. Auto animal weighing proves to be beneficial when the balance is used majority for animal weighing and less for simple weighing thus reducing the time required for animal weighing.

Procedure

- ⇒ Place the empty container on the pan.
 - ⇒ Press the <TARE> key briefly to tare the balance.
 - ⇒ Press the <TOGGLE> key briefly until " " and "AUTO" symbol appears on the display.
- Your balance now needs to set the countdown value.
- ⇒ Press and hold the <TOGGLE> key to enter countdown menu. The entire menu can be accessed by the <TOGGLE> key.
- The stability symbol indicates the currently selected countdown value.
- ⇒ Press the <TARE> key to select specific countdown value.
 - ⇒ Keep the animal on the pan, when both the condition required for animal weighing are met the countdown process will start, when the countdown time ends the average weight on animal is displayed with the display locked.

Thus there is no need of pressing a key to start the countdown process in the auto animal weighing mode.

Locked display is indicated by the flashing animal and AUTO symbol.

The countdown options available are,

t-5 (Auto), t-10 (Auto) Default, t-20 (Auto), t-50 (Auto), t-100(Auto)

You can use the <TOGGLE> key at any time to switch the display between animal weighing, weighing unit 1 and weighing unit 2. User can go to Standby mode by pressing on/off key and go to Simple Weighing with unit 1 by Cancel key and balance shows Current weights.

If the balance is connected eternally to PC or Printer through RS 232 C then, whenever user enter into the Countdown Menu of Animal Weighing & make changes in the countdown time automatically printout is generated on the Peripheral attached.

In the printout, the new countdown value 'mDef' is printed. After this user can Press Print Key to Print the reading on the display. Also user can Toggle to other unit through Toggle key & Press Print Key to get the print out of those corresponding units.

When GLP ON

Printouts generated when Unit Toggling is done between Application Unit (Anl), Unit1 and Unit2 and Reference Weight is changed

```
-----
28-Jul-10      03:19PM
  Citizen
Model          CX 220
Ser.no.        9223102
Ver.no.        r0.1.5.3
ID             1234567
-----
```

```
Cnt           20
xNt +         50.0709 g
+             50.0715 g
+             250.3575 ct
xNt +         50.0709 g
-----
```

```
28-Jul-10      03:23PM
Name:         .....
```

When GLP OFF

Printouts generated when Unit Toggling is done between Application Unit (Anl), Unit1 and Unit2 and Reference Weight is changed

```
Cnt           20
xNt +         50.0709 g
+             50.0715 g
+             250.3575 ct
xNt +         50.0709 g
```

Printout: Counting

```
Cnt           20 :      Number of subweighing
                          operations
xNt +         50.0709 g :      Calculated Average
```

- Note :** 1) User cannot enter into the external calibration or menu when GLP is ON & footer has not been printed.
2) To print footer user will have to Press <CANCEL> key.

6.5 Formulation

The formulation feature allows individual weighing values to be summed to a total.

User can select from two available formulation modes i.e. Manual formulation and auto formulation.

Maximum no of weights that can be summed is 99.

Store component weights with

- Display zeroed automatically after value is stored, and
- Automatic printout (print application parameters)
- Of the last component weight (net value) and
- Of the total weight (tare value)

Clear component memory when weighing series is canceled by pressing CANCEL key

Note :

- Individual weights can be added into summation only if the weights are greater than 20d, this is indicated by '↓' symbol.
- The weighing unit for formulation will be the same as selected.

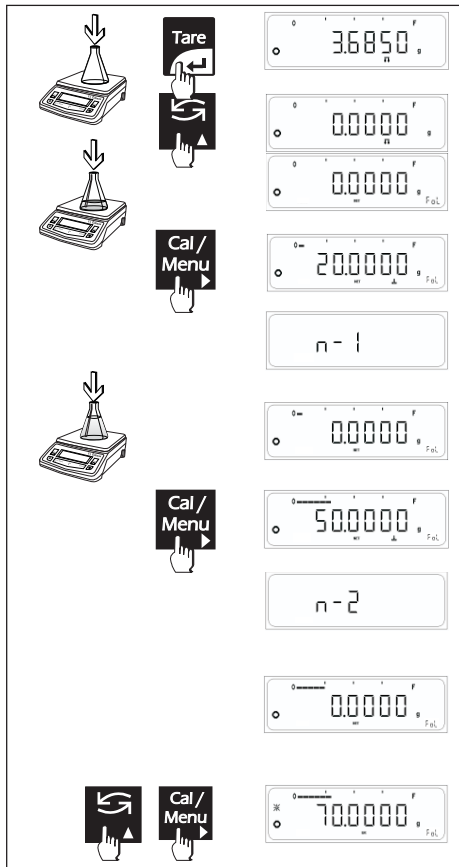

6.5.1 Manual Formulation

Manual formulation presupposes that you have selected the 'F Form' in the user menu.

Procedure

Place the empty container on the pan.

- ⇒ Press the <TARE> key briefly to tare the balance.
- ⇒ Press the <TOGGLE> key briefly until Fol is displayed on the display.
- ⇒ Add weight on the pan. Weight can be added to summation when '↓' is displayed on the display i.e. when it is greater than 20d.
- ⇒ Press the <CAL> key to store the weight, the balance displays "n-1" indicating that 1st weight is stored. The weight is tared automatically and simultaneously print command is given.

E.g. if 9.9968 gm is added the printer output is as follows

```
N1      :      9.9968 g
Tot     :      +9.9968 g
```

Further addition of weights will give the following output (addition of 20.0070 gm).

```
N2      :      20.0070 g
Tot     :      +39.0038 g
```

- ⇒ To view the total weight, press the <CAL> and <TOGGLE> key together. The print command is given automatically

```
N       2
Tot     :      + 39.0038 g
```

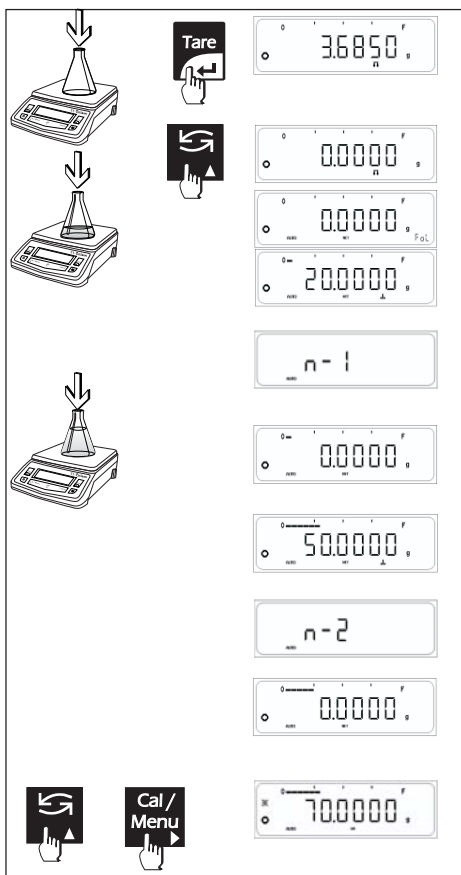

6.5.2 Auto Formulation

Auto formulation presupposes that you have selected the 'F Form AUTO' in the user menu.

Auto formulation proves to be beneficial when the balance is used in majority for formulation weighing and less for simple weighing thus reducing the time required for formulation as compared to manual formulation.

- ⇒ Place the empty container on the pan.
- ⇒ Press the <TARE> key briefly to tare the balance.
- ⇒ Press the <TOGGLE> key briefly until Fol and AUTO is displayed on the display.
- ⇒ Add weight on the pan. Weight can be added to summation when "↓" is displayed on the display i.e. when it is greater than 20d.
- ⇒ When the weight is stable the weight is stored in the formulation procedure and the balance displays "n-1" indicating that 1st weight is stored. The weight is tared automatically and simultaneously print command is given. Thus there is no need to press any to start the auto formulation procedure.

You can use the <TOGGLE> key at any time to switch the display between formulation, weighing unit 1 and weighing unit 2. User can go to Standby mode by pressing on/off key and go to Simple Weighing with unit 1 by CANCEL key and balance shows Current weights.

If the balance is connected eternally to PC or Printer through RS 232 C then, whenever user adds weight to the formulation procedure automatically printout is generated on the Peripheral attached.

In the printout, the component added 'N x' along with the total sum 'Tot' is printed. After this user can Press Print Key to Print the reading on the display.

Also user can Toggle to other unit through Toggle key & Press Print Key to get the print out of those corresponding units.

When GLP ON

Printouts generated when Unit Toggling is done between Application Unit (For), Unit1 and Unit2 and Reference Weight is changed

```

28-Jul-10      03:19PM
      Citizen
Model          CX 220
Ser. no.       9223102
Ver. no.       r0.1.5.3
ID             1234567
-----
N1 +           20.0000 g
Tot +          20.0000 g
+              20.0000 g
+              100.0000 ct
N2 +           50.0000 g
Tot +          70.0000 g
N              2
Tot +          70.0000 g
-----
28-Jul-10      03:23PM
Name:          .....
  
```

When GLP OFF

Printouts generated when Unit Toggling is done between Application Unit (For), Unit1 and Unit2 and Reference Weight is changed

```

N1 +           20.0000 g
Tot +          20.0000 g
+              20.0000 g
+              100.0000 ct
N2 +           50.0000 g
Tot +          70.0000 g
N              2
Tot +          70.0000 g
  
```

Printout Configuration

```

N1 + 20.0000 g
Tot + 20.0000 g
N2 + 50.0000 g
Tot + 70.0000 g
N      2
Tot + 70.0000 g
  
```

```

1st component and its weight
Sum of components
2nd component and its weight
Sum of components
Total number of components
Total formulation weight
  
```

Note : 1) User cannot enter into the external calibration or menu when GLP is ON & footer has not been printed.
2) To print footer user will have to Press <CANCEL> key.

6.6 Check Weighing

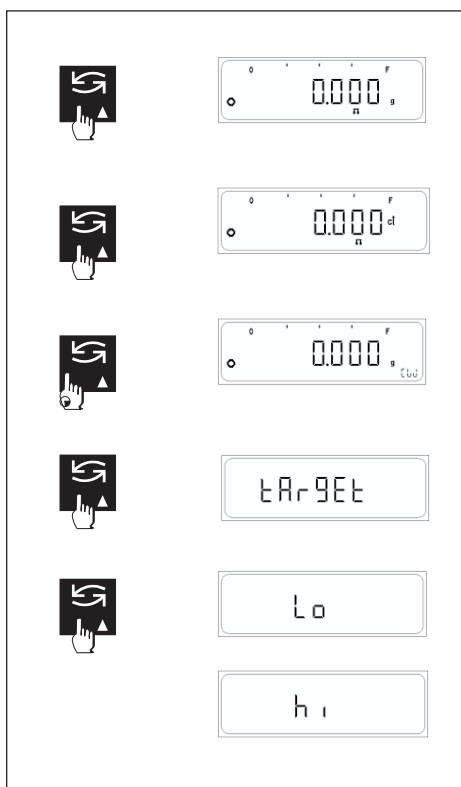

This feature is used to check whether a sample corresponds to a preset target or is with a specific tolerance range.

The results displayed can also be available on external port, which with the help of electronic processing can be used to control additional devices.

The check weighing procedure will always be carried out in unit 'gm'.

Check weighing presupposes that you have selected the 'F CHW' in the user menu.

Procedure

- ⇒ Press the <TARE> key briefly to tare the balance.
 - ⇒ Press the <TOGGLE> key briefly until "CW" is displayed on the display.
Your balance now needs the target and tolerance values.
- If entering the check weighing for the first time the target and tolerance setting menu will be displayed.

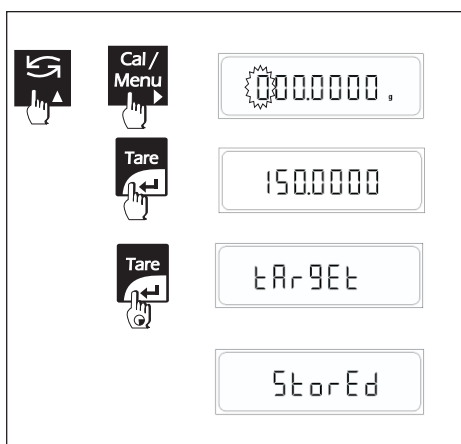

Target and Tolerance Settings

- ⇒ Press and hold the <TOGGLE> until the target and tolerance setting menu is prompted.
- ⇒ Press the <TOGGLE> key to browse through the TARGET, HI, and LOW setting.
- ⇒ Press the <TARE> key to enter specific setting.
- ⇒ Press the <TOGGLE> key (▲) to change the value of the flashing digit.
- ⇒ Press the <CAL> key (▶) to change the flashing digit from left to right.
- ⇒ After proper setting of values press the <TARE> key.
- ⇒ Press and hold the <TARE> key to store the values of target and tolerance values.

Note: To view the weight when the balance displays LL or HH press the <CAL> key press the <CAL> key again to display LL or HH.

For Low Range

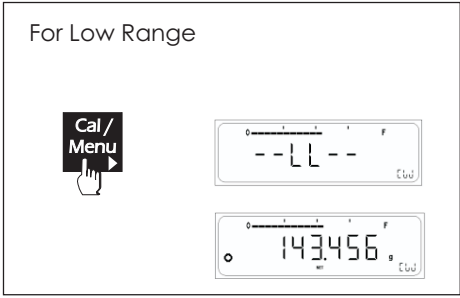

Load the weight on the pan and the balance will display the results according to the preset values of target and tolerance.

E.g. If the values are as follows,
 TARGET = 150.0000 gm
 HI = 155.0000 gm
 LOW = 145.0000 gm

Now if 144.0000 gm is loaded on the pan the display shows LL indicating that the loaded weight is less than the low value set.

If 156.0000 gm is loaded on the pan the display shows HH indicating that the loaded weight is greater than the high value set.

While the balance displays LL or HH the buzzer will beep continuously to indicate that the weight is out of the tolerance band and the corresponding lines on the external will be enabled.

If the weight is in the tolerance range the balance will display the weight similar to simple weighing.

You can use the <TOGGLE> key at any time to switch the display between check weighing, weighing unit 1 and weighing unit 2.

User can go to Standby mode by pressing on/off key and go to Simple Weighing with unit 1 by CANCEL key and balance shows Current weights.

For High Range

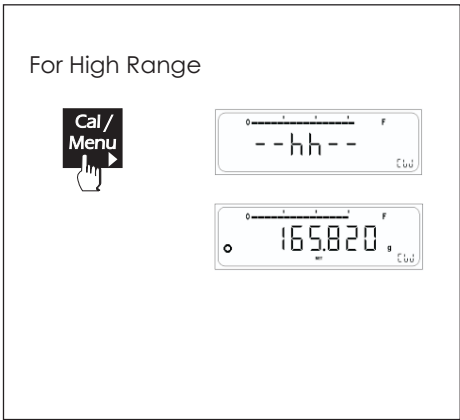

If the balance is connected eternally to PC or Printer through RS 232 C then, whenever user enter into the Target and Tolerance Setting Menu of Check Weighing Menu & make changes in the setting, automatically printout is generated on the Peripheral attached.

In the printout, Target and Tolerance value are printed. After this user can Press Print Key to Print the reading on the display. Also user can Toggle to other unit through Toggle key & Press Print Key to get the print out of those corresponding units.

When GLP ON

Printouts generated when Unit Toggling is done between Application Unit (Chw), Unit1 and Unit2 and Reference Weight is changed

```

-----
28-Jul-10      03:19PM
      Citizen
Model          CX 220
Ser.no.        9223102
Ver.no.        r0.1.5.3
ID             1234567
-----
Target         150.0000 g
Hi             160.0000 g
Lo             140.0000 g
-----LL-----
+              99.9979 g
+              149.9979 g
-----HH-----
+              200.0029 g
-----
28-Jul-10      03:23PM
Name:
.....
-----
    
```

When GLP OFF

Printouts generated when Unit Toggling is done between Application Unit (Chw), Unit1 and Unit2 and Reference Weight is changed

```

Target         150.0000 g
Hi             160.0000 g
Lo             140.0000 g
-----LL-----
+              99.9979 g
+              149.9979 g
-----HH-----
+              200.0029 g
    
```

Note : 1) User cannot enter into the external calibration or menu when GLP is ON & footer has not been printed.
 2) To print footer user will have to Press <CANCEL> key.

6.7 Totalization

The totalization procedure allows individual weighing pieces to be summed to a total.

User can select from two available formulation modes i.e. Manual totalization and auto totalization.

Maximum no of weights that can be summed is 99.

Store component pieces with

- Display zeroed automatically after value is stored, and
- Automatic printout (print application parameters)
- Of the last added pieces and
- Of the total number of pieces.

Clear component memory when weighing series is canceled by pressing CANCEL key

Note:

- Individual weights can be added into summation only if the added pieces is greater than 2, this is indicated by "↓" symbol.

6.7.1 Manual Totalization

Procedure

Manual totalization presupposes that you have selected the 'F tot' in the user menu.

- ⇒ Place the empty container on the pan.
- ⇒ Press the <TARE> key briefly to tare the balance.
- ⇒ Press the <TOGGLE> key briefly until "tot" is displayed on the display. Your balance now needs the weight of a reference number.
- ⇒ Press and hold the <TOGGLE> key until you are prompted to load the reference pieces.

73

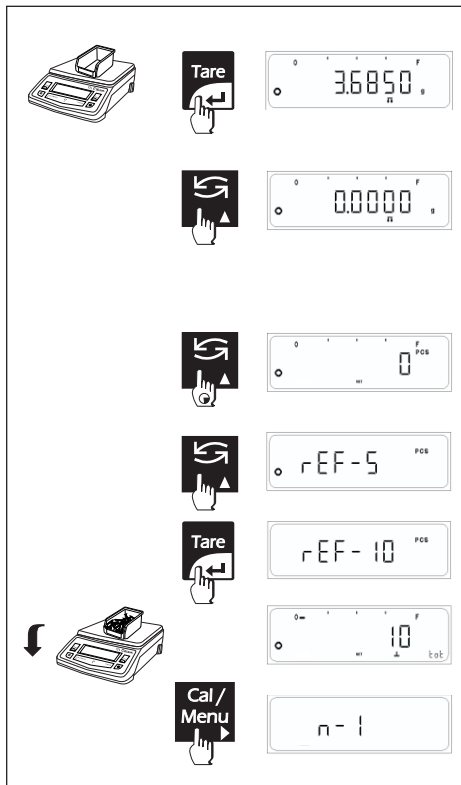

- ⇒ Your balance suggests the last set reference no. as the reference number. You can accept this suggestion or select one of the other reference numbers available (5, 10, 20, 50, 100 pieces) by briefly pressing the <TOGGLE> key.
- ⇒ Now place the selected number of reference pieces on the pan.
- ⇒ When you have placed exactly the same number of pieces on the weighing pan as selected reference pieces press TARE key. As soon as the weighing result is stable, the calculated average piece weight is accepted as the reference.
- ⇒ Add weight on the pan. Weight can be added to summation when "↓" is displayed on the display i.e. when number of pieces is greater than 2.
- ⇒ Press the <CAL> key to store the weight, the balance displays "n-1" indicating that 1st weight is stored. The weight is tared automatically and simultaneously print command is given.

E.g. if 20.0000 gm and the reference is selected as 5, the printer output is as follows

```
nRef      5 pcs
wRef      4 g
N1+      5 pcs
Tot+      5 pcs
```

Further addition of weights will give the following output (addition of 10.0000 gm).

```
N2+      2 pcs
Tot+      7 pcs
```

- ⇒ To view the total weight, press the CAL and NEXT key together. The print command is given automatically

```
N        2
Tot+     7 pcs
```

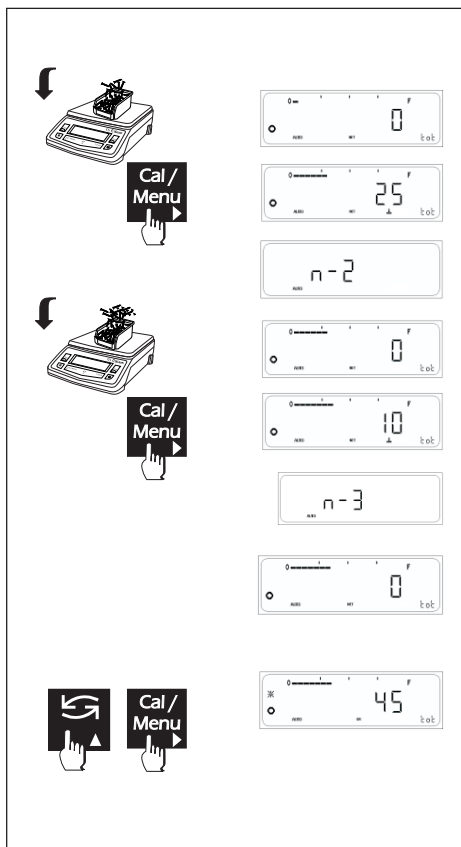

74

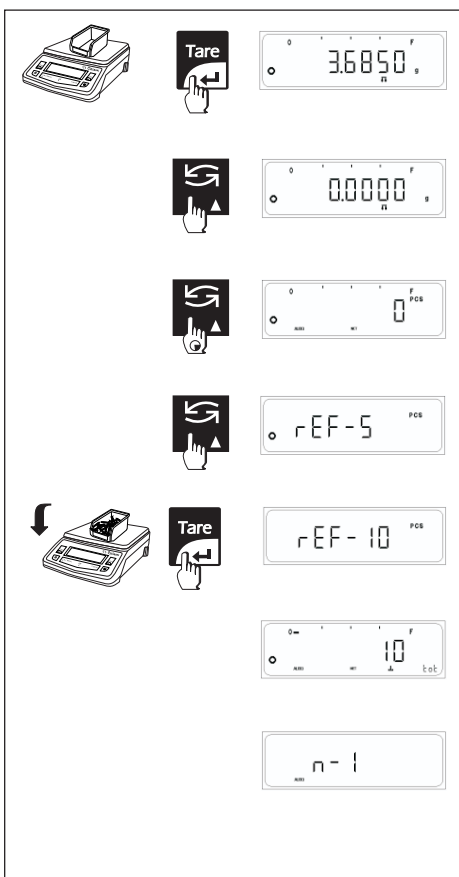

6.7.2 Auto Totalization

Auto totalization presupposes that you have selected the 'F tot AUTO' in the user menu. Auto totalization proves to be beneficial when the balance is used in majority for totalization weighing and less for simple weighing thus reducing the time required for totalization as compared to manual totalization

Procedure

- ⇒ Place the empty container on the pan.
- ⇒ Press the <TARE> key briefly to tare the balance.
- ⇒ Press the <TOGGLE> key briefly until "tot" and AUTO is displayed on the display. Your balance now needs the weight of a reference number.
- ⇒ Press and hold the <TOGGLE> key until you are prompted to load the reference pieces.
- ⇒ Your balance suggests the last selected reference number. You can accept this suggestion or select one of the other reference numbers available (5, 10, 20, 50, 100 pieces) by briefly pressing the <TOGGLE> key.
- ⇒ Now place the selected number of reference pieces on the pan.
- ⇒ When you have placed exactly the same number of pieces on the weighing pan as selected reference pieces press TARE key. As soon as the weighing result is stable, the calculated average piece weight is accepted as the reference.
- ⇒ Add weight on the pan. Weight can be added to summation when "↓" is displayed on the display i.e. when number of pieces is greater than 2.
- ⇒ When the weight is stable the number of pieces is stored in the totalization procedure and the balance displays "n-1" indicating that 1st weight is stored. The weight is tared automatically and simultaneously print command is given. Thus there is no need to press any to start the auto totalization procedure.

Note : You can use the <TOGGLE> key at any time to switch the display between totalization, weighing unit 1 and weighing unit 2. User can go to Standby mode by pressing on/off key and go to Simple Weighing with unit 1 by CANCEL key and balance shows Current weights.

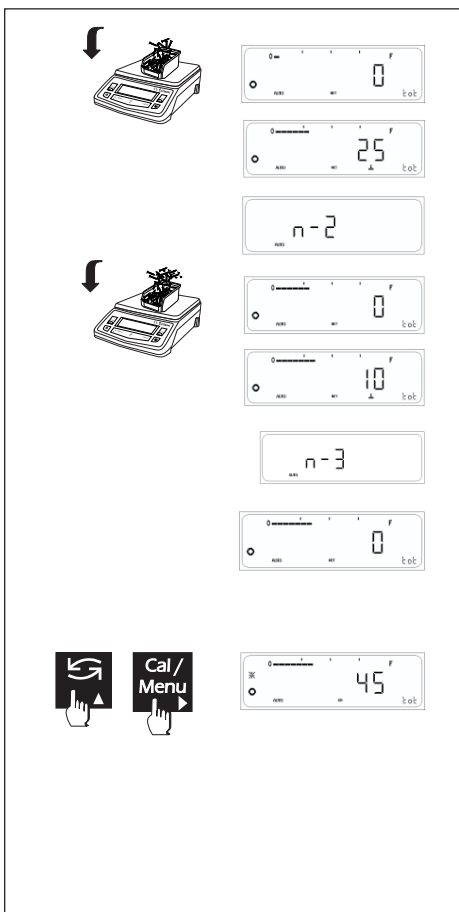

If the balance is connected externally to PC or Printer through RS 232 C then, whenever user enter into the reference menu of Totalization function & make changes in the reference setting, automatically printout is generated on the Peripheral attached.

In the printout, reference number "nRef" and reference weight "wRef" is printed. After this user can Press Print Key to Print the reading on the display. Also user can Toggle to other unit through Toggle key & Press Print Key to get the print out of those corresponding units.

When GLP ON

Printouts generated when Unit Toggling is done between Application Unit (Tot), Unit1 and Unit2 and Reference Weight is changed

```

-----
28-Jul-10          03:19PM
          Citizen
Model            CX 220
Ser.no.          9223102
Ver.no.          r0.1.5.3
ID               1234567
-----
nRef              10 pcs
wRef              2.0000 g
N1 +              10 pcs
Tot +             10 pcs
N2 +              25 pcs
Tot +             35 pcs
N3 +              10 pcs
Tot +             45 pcs
N                 3
Tot +             45 pcs
-----

```

When GLP OFF

Printouts generated when Unit Toggling is done between Application Unit (Tot), Unit1 and Unit2 and Reference Weight is changed

```

nRef              10 pcs
wRef              2.0000 g
N1 +              10 pcs
Tot +             10 pcs
N2 +              25 pcs
Tot +             35 pcs
N3 +              10 pcs
Tot +             45 pcs
N                 3
Tot +             45 pcs
-----

```

```

28-Jul-10          03:23PM
Name:
-----

```

- Note :**
- 1) User cannot enter into the external calibration or menu when GLP is ON & footer has not been printed.
 - 2) To print footer user will have to Press <CANCEL> key.

6.8 Density Determination

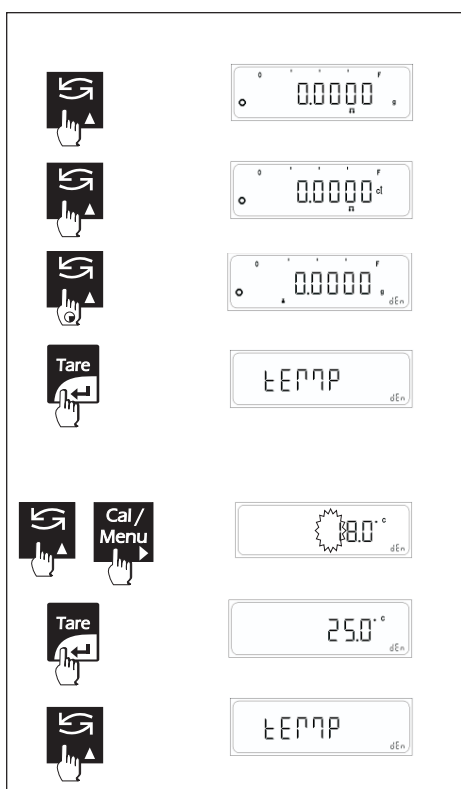

The density is determined applying the principle of Archimedes, which states that any body immersed in a fluid becomes lighter by an amount equal to the weight of the fluid that it has displaced.

Purity of gold can also be determined on the basis of density.

The weighing unit of density determination will be 'grams'.

Density determination presupposes that you have selected the 'F Den' in the user menu.

To calculate the density of sample, the balance should know the type of liquid and its temperature, used to calculate the density of solid.

Procedure

- ⇒ Press and hold the <TOGGLE> until the functionality menu is prompted.
- ⇒ Press the <TOGGLE> key to browse through the Temperature, Liquid and Mode settings.

Temperature Setting

- ⇒ Press the <TARE> key when the 'temp' is displayed.
- ⇒ Press the <TOGGLE> key (▲) to change the value of the flashing digit.
- ⇒ Press the <CAL> key (▶) to change the flashing digit from left to right.
- ⇒ After proper setting of values press the <TARE> key.
- ⇒ The default value of temperature is **25.0°C**
- ⇒ This setting is alterable only when the liquid selected is water or ethanol. If the liquid selected is 'Other' the temperature setting will 'nA' i.e. Not applicable.

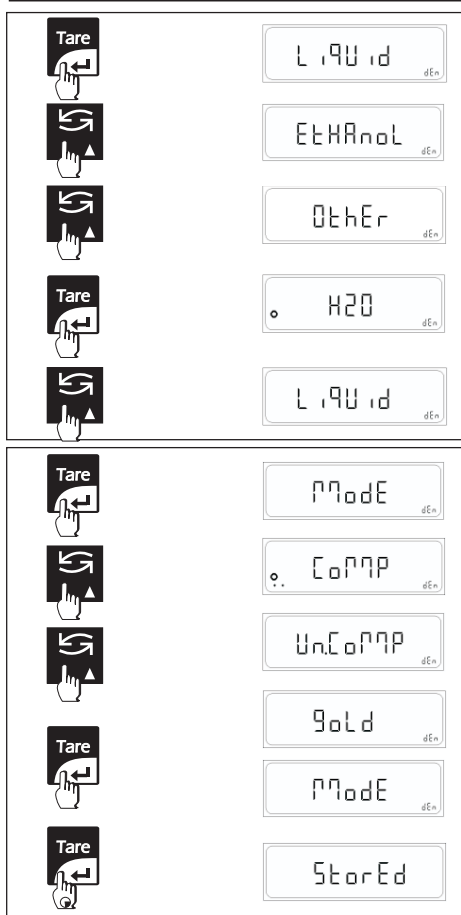

Liquid Setting

You can select from the three available options i.e. water, ethanol and other.

- ⇒ Press the <TOGGLE> key to change the liquid option.
- ⇒ After proper selection of the liquid setting the <TARE> key.

The default option is distilled water.

Mode Setting

You can select from three options i.e. compensated, uncompensated and purity of gold.

- ⇒ Press the <TOGGLE> key to change the Mode setting.
- ⇒ After proper selection of mode press the <TARE> key .

The default option is compensated.

The results of purity of gold will be shown in carats.

Cal / Menu

Add Wt. in Air

Cal / Menu

Add Wt. in Liquid

Cal / Menu

Density Determination Procedure

- ⇒ Attach the Density determination Kit to the Balance
- ⇒ Press the <TARE> key briefly to TARE the balance.
- ⇒ Press the <TOGGLE> key briefly until "Den" appears on the display.
- ⇒ Press the <CAL> key to start the density determination procedure. The Balance now asks for weight of the sample in air. (With Wt.Air flashing on the display every 10 seconds)
- ⇒ Place the sample on density determination kit, When the weight is stable press the CAL key to accept the weight of sample in air.
- ⇒ Now the balance asks for the weight of sample in liquid (With Wt.Liqd flashing on the display every 10 seconds)
- ⇒ Now immerse the sample in the liquid, When the weight is stable press the CAL key to accept the weight of sample in liquid.
- ⇒ The balance will show the results upon the selected mode i.e. compensated, uncompensated or gold.

Display for compensated density

Display for uncompensated density

Density Calculations

With compensation for air density

$$\rho = \frac{A * (\rho_0 - \rho_l)}{(A - B)} + \rho_l$$

ρ = density of sample
 A = weight of sample in air
 B = weight of sample in auxiliary liquid
 ρ_0 = density of auxiliary liquid
 ρ_l = air density (0.0012 g/cm³)

e.g.

$$\begin{aligned} \rho &= (A / (A - B)) (\rho_0 - \rho_l) + \rho_l \\ &= (20.000 / (20.000 - 18.935)) (0.99689 - 0.0012) + 0.0012 \\ &= 18.699 \text{ g/cm}^3 \end{aligned}$$

Without compensation for air density

$$\rho = \frac{A}{(A - B)} * \rho_0$$

$\rho = \rho_0 (A / (A - B))$
 e.g.

$$\begin{aligned} \rho &= \rho_0 (A / (A - B)) \\ &= (20.000 / (20.000 - 18.935)) (0.99689) \\ &= 18.721 \text{ g/cm}^3 \end{aligned}$$

If the balance is connected externally to PC or Printer through RS 232 C then, whenever user enter into the menu of Density function & make changes in the, automatically printout is generated on the Peripheral attached.

In the printout, Temperature, Liquid and Mode are printed. After this user can Press Print Key to Print the reading on the display. Also user can Toggle to other unit through Toggle key & Press Print Key to get the print out of those corresponding units.

When GLP ON

Printouts generated when Unit Toggling is done between Application Unit (**Den**), Unit1 and Unit2 and Reference Weight is changed

```

-----
28-Jul-10      03:19PM
      Citizen
Mode1          CX 220
Ser.no.        9223102
Ver.no.        r0.1.5.3
ID             1234567
-----
Mode           GOLD
Liquid         WATER
Temperature    25.0
Pur +         23.1 ct
+             18.9350 g
+             94.675 ct
-----
28-Jul-10      03:23PM
Name:
.....
-----

```

When GLP OFF

Printouts generated when Unit Toggling is done between Application Unit (**Den**), Unit1 and Unit2 and Reference Weight is changed

```

-----
Mode           GOLD
Liquid         WATER
Temperature    25.0
Pur +         23.1 ct
+             18.9350 g
+             94.675 ct
-----

```

- Note :** 1) User cannot enter into the external calibration or menu when GLP is ON & footer has not been printed.
 2) To print footer user will have to Press <CANCEL> key.

If the balance is connected externally to PC or Printer through RS 232 C then, whenever user enter into the menu of Density function & make changes in the, automatically printout is generated on the Peripheral attached.

In the printout, Temperature, Liquid and Mode are printed. After this user can Press Print Key to Print the reading on the display. Also user can Toggle to other unit through Toggle key & Press Print Key to get the print out of those corresponding units.

When GLP ON

Printouts generated when Unit Toggling is done between Application Unit (**Den with Compensated Mode Liquid as Ethanol**), Unit1 and Unit2 and Reference Weight is changed

```

-----
28-Jul-10      03:19PM
      Citizen
Mode1          CX 220
Ser.no.        9223102
Ver.no.        r0.1.5.3
ID             1234567
-----
Mode           COMPENSATED
Liquid         ETHANOL
Temperature    28.0
Den +         0.6995g/c3
+             18.9350 g
+             94.675 ct
-----
28-Jul-10      03:23PM
Name:
.....
-----

```

When GLP ON

Printouts generated when Unit Toggling is done between Application Unit (**Den with Uncompensated Mode and Liquid as None**), Unit1 and Unit2 and Reference Weight is changed

```

-----
28-Jul-10      03:19PM
      Citizen
Mode1          CX 220
Ser.no.        9223102
Ver.no.        r0.1.5.3
ID             1234567
-----
Mode           UNCOMPENSATED
Liquid         OTHER
Temperature    NA
Den +         0.6994g/c3
+             18.9350 g
+             94.675 ct
-----
28-Jul-10      03:23PM
Name:
.....
-----

```

- Note :** 1) User cannot enter into the external calibration or menu when GLP is ON & footer has not been printed.
 2) To print footer user will have to Press <CANCEL> key.

6.9 Pipette Calibration

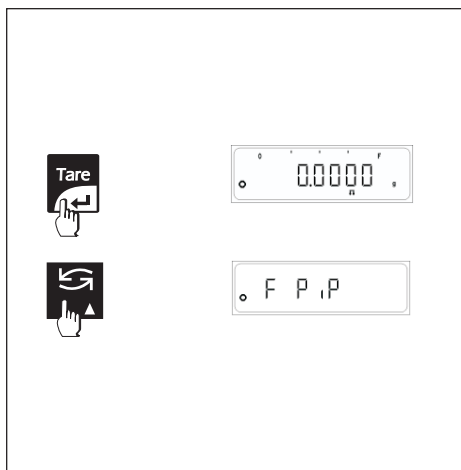

In laboratories, where pipettes are used for experimenting with liquids, it becomes important to calibrate the pipette. Thus this feature enables the user to calibrate the pipette. The feature "pipette calibration" can be activated by selecting the "F PiP" function in the menu. By pressing the CAL/MENU key for 4 seconds the user can enter the User menu and select the "F PiP" function.

Note: The below procedure presupposes that you have selected the 'F PiP' function in the user menu.

Procedure

- ⇒ Place the empty container on the pan.
- ⇒ Press the <TARE> key briefly to tare the balance.
- ⇒ Press the <TOGGLE> key for 2 seconds to enter the F PiP function.

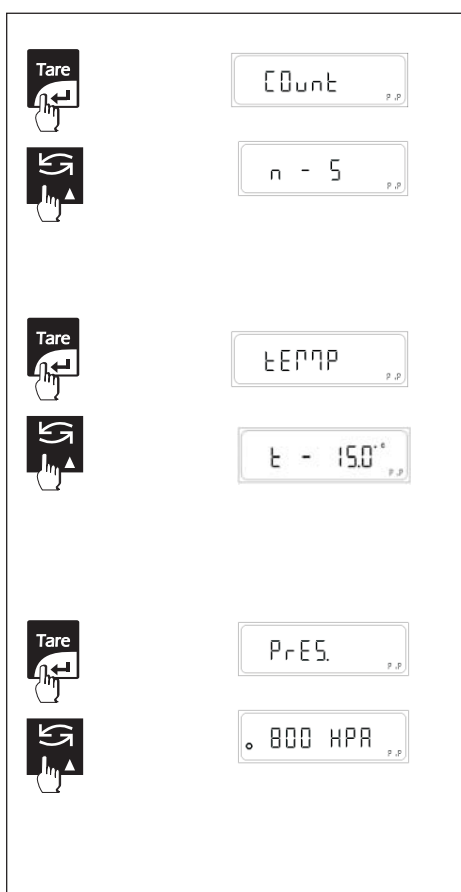

Note: To enter the settings below, it is assumed that the user has already performed the above procedure and the scale is in F PiP mode.

Count Cycle Settings

- ⇒ Press <TOGGLE> key to enter F PiP settings.
- ⇒ Press <TARE> to enter the count settings.
- ⇒ 'n' represents the number of calibration cycles the user intends to perform. 'n' can have any value between 5 and 15 (including both).
- ⇒ Press <TOGGLE> to select the required value of 'n'.
- ⇒ Press <TARE> once to select the value of 'n' and return to F PiP settings.
- ⇒ The default count value is 5.

Temperature settings

- ⇒ Press <TOGGLE> key to enter F PiP settings.
- ⇒ Select 'TEMP' in F PiP settings by pressing <TOGGLE> key.
- ⇒ Press <TARE> to enter the 'TEMP' settings.
- ⇒ The user can select from a list of 30 predefined temperatures ranging from 15.0°C to 30.0°C with a step interval of 0.5°C.
- ⇒ Change the temperature value by pressing <TOGGLE> key and then select it pressing <TARE>. This will bring you back to F PiP settings.
- ⇒ The default temperature is 25.0°C

Pressure Settings

- ⇒ Press <TOGGLE> key to enter F PiP settings.
- ⇒ Select 'PRES' in F PiP settings by pressing <TOGGLE> key.
- ⇒ Press <TARE> to enter the 'PRES' settings.
- ⇒ The user can select from a list of 7 predefined pressures ranging from 800 hPa to 1050 hPa with step interval of 50 hPa.
- ⇒ Change the pressure value by pressing the <TOGGLE> key and then select it pressing <TARE>. This will bring you back to 'FPiP' settings.
- ⇒ The default pressure is 800 hPa.



Volume Settings:

Initial volume V_0 :

- ⇒ Press <TOGGLE> key to enter F PiP settings.
- ⇒ Select ' V_0 ' in F PiP settings by pressing <TOGGLE> key.
- ⇒ Press <TARE> to enter the ' V_0 ' settings.
- ⇒ The user can change the volume with the help of <CAL/MENU> key and <TOGGLE>key.
- ⇒ Pressing the <CAL/MENU> key will shift the cursor to the right in a cyclic way and pressing the <TOGGLE> key will increment the digit.
- ⇒ Press the <TARE> key to select the value. This will bring you back to the F PiP menu
- ⇒ The default volume is, $V_0 = 10.00 \mu\text{L}$

Half volume V_{Half} :

- ⇒ Press <TOGGLE> key to enter F PiP settings.
- ⇒ Select ' V_{Half} ' in F PiP settings by pressing <TOGGLE> key.
- ⇒ Press <TARE> to enter the ' V_{Half} ' settings.
- ⇒ The user can change the volume with the help of <CAL/MENU> key and <TOGGLE>key.
- ⇒ Pressing the <CAL/MENU> key will shift the cursor right in a cyclic way and pressing the <TOGGLE> key will increment the digit.
- ⇒ Press the <TARE> key to select the value. This will bring you back to the F PiP menu
- ⇒ The default volume is, $V_{\text{Half}} = 11.00 \mu\text{L}$

Full volume, V_{Full} :

- ⇒ Press <TOGGLE> key to enter F PiP settings.
- ⇒ Select ' V_{Full} ' in F PiP settings by pressing <TOGGLE> key.
- ⇒ Press <TARE> to enter the ' V_{Full} ' settings.
- ⇒ The user can change the volume with the help of <CAL/MENU> key and <TOGGLE>key.
- ⇒ Pressing the <CAL/MENU> key will shift the cursor right in a cyclic way and pressing the <TOGGLE> key will increment the digit.
- ⇒ Press the <TARE> key to select the value. This will bring you back to the F PiP menu
- ⇒ The default volume is, $V_{\text{Full}} = 12.00 \mu\text{L}$.

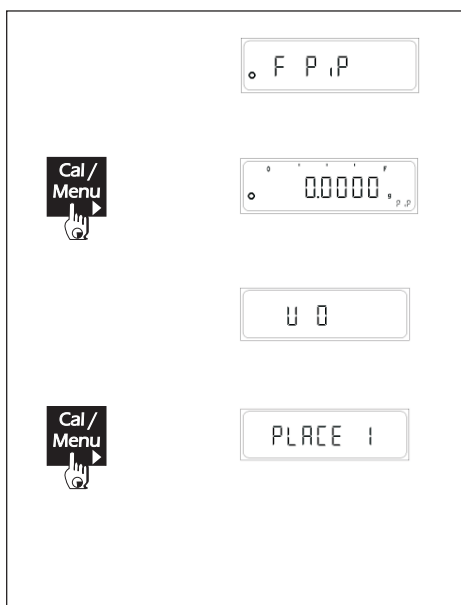

Note:

- ⇒ It is assumed that the user has already performed the above procedure and the scale is in F PiP mode.
- ⇒ When the pipette calibration procedure process has not started the system will perform normal weighing with the unit as gm.

Calibration procedure:

- ⇒ The calibration procedure repeats itself 'n' times where 'n' is the count entered in the count cycle settings (in F PiP settings).
- ⇒ Once in F PiP mode, press the <CAL/MENU> key to start the calibration process.
- ⇒ Once the <MENU/CAL> key is pressed, it will ask for the initial volume V_0 .
- ⇒ For a calibration procedure of 'n' times, the scale will ask for V_0 'n' times. Each of these value will be stored as 'PLACE n'.
- ⇒ Thus, for the 1st time, place the initial volume and press <CAL/MENU> key once the stability is achieved. This is accepted as 'PLACE 1'.
- ⇒ Follow the above procedure for 'PLACE 1' to 'PLACE n'.
- ⇒ Repeat the above procedure for half volume V_{half} and full volume V_{full} each 'n' times respectively.
- ⇒ In case of a successful calibration the scale will display 'PiP done'. If not, then it will ask to repeat the step wrongly performed.

If the balance is connected externally to PC or Printer through RS 232 C then, whenever user enter into the menu of Pipette Calibration & make changes in it, automatically printout is generated on the Peripheral attached.

The following are the parameters that are Printed along with the readings :

WITH GLP OFF

PIPETTE CAL. RESULTS

Count : 5 Cnt
 Temp. : 15.0 °C
 Pressure : 800 hPa
 Results : Vmin

1 10016.45 uL
 2 10016.45 uL
 3 10016.35 uL
 4 10016.35 uL
 5 10016.35 uL

Vmin = 10.00 uL
 Va = 10016.39 uL
 Es = 10006.39 uL
 Es% = 100063.88 %
 Sr = 0.05 uL
 CV = 0.00 %

Results : V1/2

1 15023.12 uL
 2 15023.12 uL
 3 15024.42 uL
 4 15024.42 uL
 5 15024.12 uL

V1/2 = 11.00 uL
 Va = 15023.84 uL
 Es = 15012.84 uL
 Es% = 136480.37 %
 Sr = 0.67 uL
 CV = 0.00 %

Results : Vmax

1 20032.40 uL
 2 20032.30 uL
 3 20032.30 uL
 4 20032.20 uL
 5 20032.20 uL

Vmax = 12.00 uL
 Va = 20032.28 uL
 Es = 20020.28 uL
 Es% = 166835.63 %
 Sr = 0.08 uL
 CV = 0.00 %

Legend

Va : Mean Value
 Es : Systematic Error
 Es% : Es expressed as % of nominal value
 Sr : Standard Deviation
 CV : Coefficient of Variation

If the balance is connected externally to PC or Printer through RS 232 C then, whenever user enter into the menu of Pipette Calibration & make changes in it, automatically printout is generated on the Peripheral attached.

The following are the parameters that are Printed along with the readings :

WITH GLP ON

11-Apr-11 00:18

Citizen

Model 00Ct603
 Ser.no. 1012652
 Ver.no. r0.1.5.8
 ID 1234567

PIPETTE CAL. RESULTS

Count : 5 Cnt
 Temp. : 15.0 °C
 Pressure : 800 hPa

Results : Vmin

1 10016.45 uL
 2 10016.15 uL
 3 10015.75 uL
 4 10015.75 uL
 5 10015.65 uL

Vmin = 10.00 uL
 Va = 10015.95 uL
 Es = 10005.95 uL
 Es% = 100059.47 %
 Sr = 0.34 uL
 CV = 0.00 %

Results : V1/2

1 15023.82 uL
 2 15023.62 uL
 3 15023.62 uL
 4 15023.62 uL
 5 15023.72 uL

V1/2 = 11.00 uL
 Va = 15023.68 uL
 Es = 15012.68 uL
 Es% = 136478.92 %
 Sr = 0.09 uL
 CV = 0.00 %

Results : Vmax

1 20031.89 uL
 2 20031.89 uL
 3 20031.89 uL
 4 20031.59 uL
 5 20031.59 uL

Vmax = 12.00 uL
 Va = 20031.77 uL
 Es = 20019.77 uL
 Es% = 166831.45 %
 Sr = 0.16 uL
 CV = 0.00 %

Legend

Va : Mean Value
 Es : Systematic Error
 Es% : Es expressed as % of nominal value
 Sr : Standard Deviation
 CV : Coefficient of Variation

11-Apr-11 00:18
 Name:

6.10 Statistics

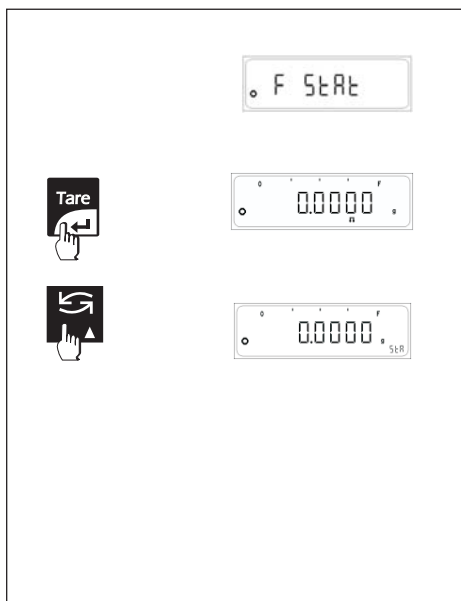

With this feature, the user can obtain the statistics of the data stored in the scale. These statistics includes the details such as number of readings 'n', Average, Minimum value, Maximum value, Standard deviation, Difference and Co efficient of Variance.

The feature 'F StAt' can be activated by selecting the 'F StAt' function in the menu. This can be done by pressing the <CAL/MENU> key for 4 seconds and changing the feature by <TOGGLE> key. Press <TARE> key to select 'F StAt'. press <TARE> for 2 seconds to store the selection.

The below procedure presupposes that you have selected the 'F StAt' function in the user menu.

Procedure

- ⇒ Place the empty container on the pan.
- ⇒ Press the <TARE> key briefly to tare the balance.
- ⇒ Press the <TOGGLE> key for entering the 'F StAt' function.

Note: To use the 'F StAt' function, it is assumed that the user has already performed the above procedure and the scale is in 'F StAt' mode.

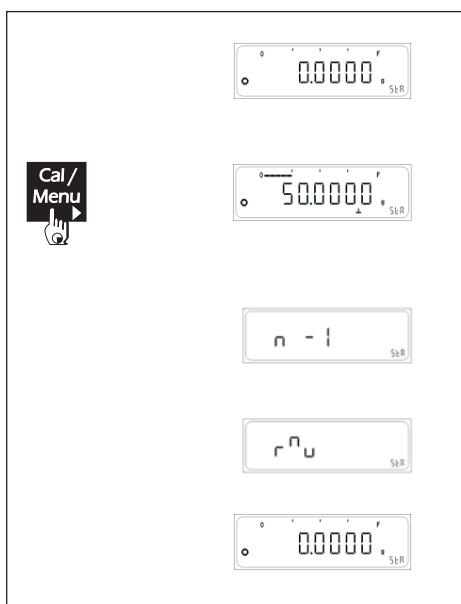

Statistics procedure

- ⇒ The user can now place weight on the pan and press the <CAL/MENU> key once the stability is achieved.
- ⇒ The scale should display 'n-1' (where 'n' is the number of the current weight) and will retain this as first weight.
- ⇒ "rmv" will be displayed on screen for 2 seconds to instruct the user to unload the weight.
- ⇒ The next weight will be taken into statistics only after user has taken off the weight from the pan, such that the weight on the pan should now be 0.0000g.
- ⇒ Repeat the above procedure for rest of the data entries.

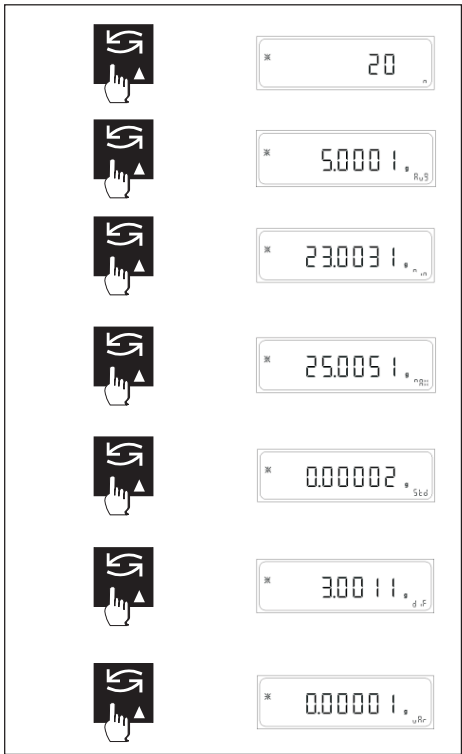

Reading the statistics

- ⇒ At any point of time, the user can press and hold the <TOGGLE> key for 2 seconds to go through the statistics.
- ⇒ The screen will display the 1st parameter as number of readings 'n' along with the star symbol which indicates that the user is in the statistics result mode.
- ⇒ The user can now go through the other parameters such as average, Min value, Max value, Standard deviation, Difference, Co efficient of Variance by pressing the <TOGGLE> key.
- ⇒ The user can come out of the statistics mode by pressing the <CANCEL > key.

Deleting statistics:

- ⇒ The user can delete the statistics by pressing the <TARE> key for 2 seconds when in 'StAt' mode.
- ⇒ This will delete the previous data entries and start again.
- ⇒ The entire data is will be sent to the terminal or to the printer before it gets deleted.

Note:

- ⇒ The minimum weight on the pan should be 10d (where'd' is the accuracy of the scale), if less than that, then the weight will not be taken into consideration for calculating statistics.
- ⇒ The statistics will be deleted if the system goes into standby mode (i.e. if the auto-off feature is active or by power on-off).
- ⇒ The user can also print the statistics by pressing the <PRINT> key when in 'StAt' mode.

If the balance is connected externally to PC or Printer through RS 232 C then, whenever user enter into the menu of Statistics & presses in the print key , the user can obtain the list of parameters shown in the below example :

WITH GLP ON

```

-----
28-Jul-10      03:19PM
      Citizen
Model         CX 220
Ser.no.       9223102
Ver.no.       r0.1.5.3
ID            1234567
-----
1 +           1.5750 g
2 +           2.3500 g
3 +           7.8950 g
4 +           4.1750 g
-----
n              4
max            7.8950 g
min            1.5750 g
avg            3.9987
std            2.8169
var            7.9349
-----
28-Jul-10      03:23PM
Name:
.....
-----

```

WITH GLP OFF

```

-----
1 +           1.5750 g
2 +           2.3500 g
3 +           7.8950 g
4 +           4.1750 g
-----
n              4
max            7.8950 g
min            1.5750 g
avg            3.9987
std            2.8169
var            7.9349
-----





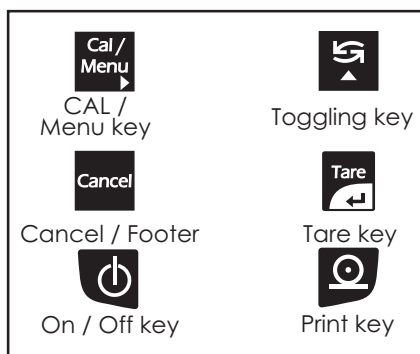
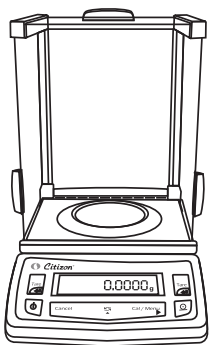





```

Key Functionality in parameter settings mode



7. Parameter Settings

The following section explains key functionality in parameter settings mode.

Press briefly 	Press & Hold 
 Change Sub Menu Setting  Increments the value of digit	
 Change Main menu options  Shifts the digit from left to right	
 Confirm Setting	 Store and quit menu (Auto Cal Menu)
 To Change Time Format (AM / PM / 24 hours) in Time Settings	
 Quit the Current Parameter Menu	

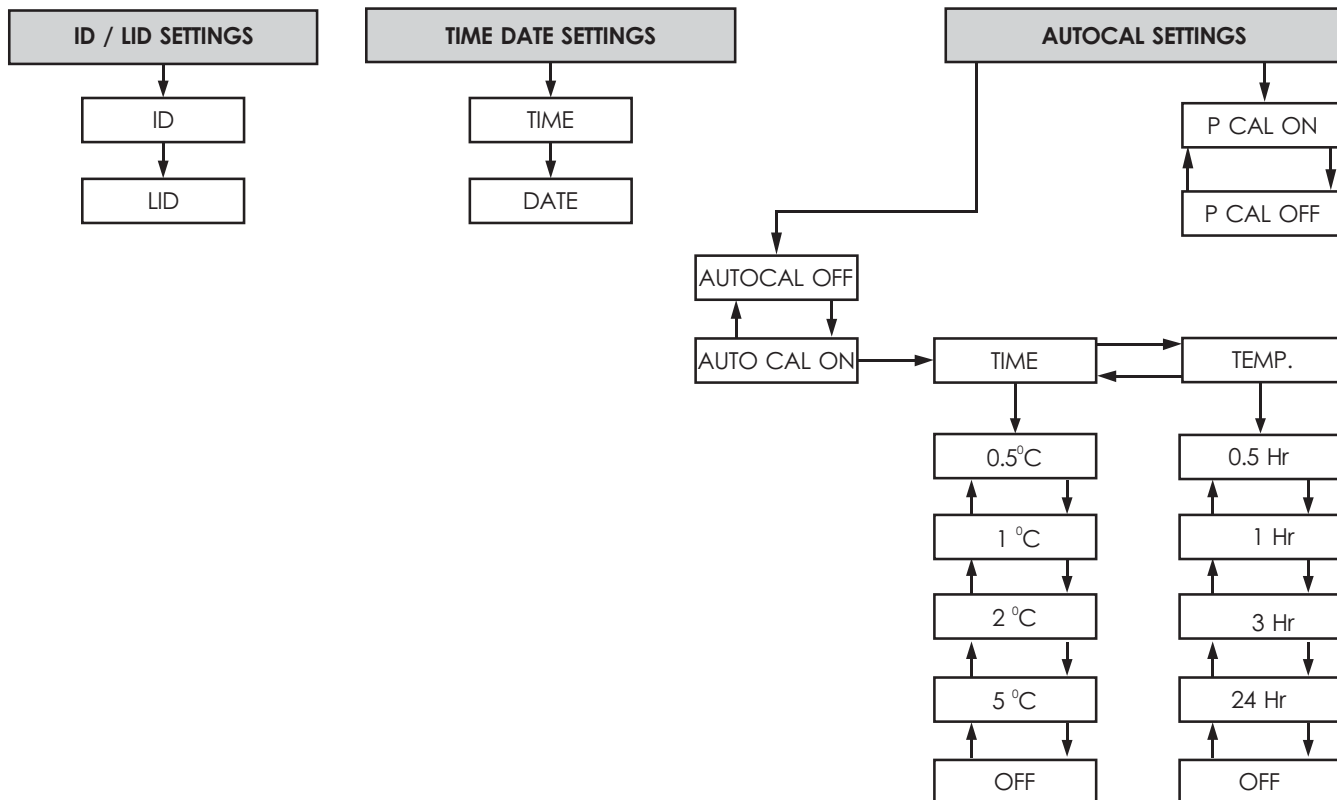

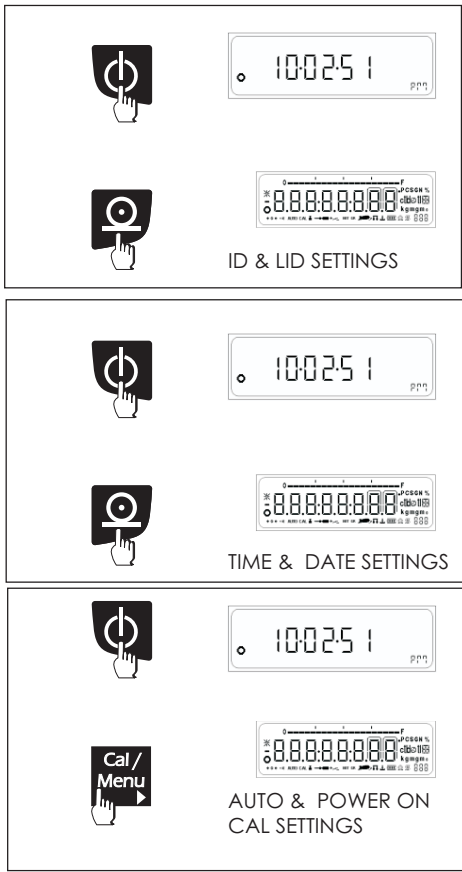

Parameter Settings

By accessing the parameter menus the user can change the following settings.

- ID and LID settings.
- Time and Date Settings.
- Auto Calibration and Power On Calibration Settings.

Operating Instructions

These menus can be accessed by pressing the PRINT key or CAL key when all the characters of the display when coming out of stand by mode or Power On.

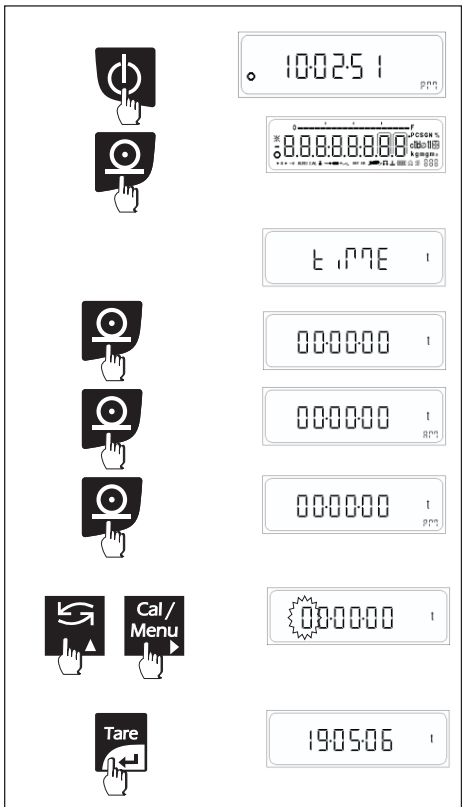

7.1 Time & Date Setting

In this menu, User can set the Clock.

Clock setting consist of 2 settings. They are

TIME : In this submenu user can set the time in hours, minutes & seconds AM, PM & 24 hrs.

DATE : In this submenu user can set the date, Month & Years

Operating Instructions

⇒ Press the PRINT key for 2 sec when coming out from stand by or Power on mode.

7.1.1 SET TIME

- ⇒ Current Time is displayed with first digit flashing. Flashing digit indicates that digit value or place can be changed.
- ⇒ Press TOGGLE key (▲) to change the value of the Flashing digit.
- ⇒ Press CAL key (▶) to shift the flashing digit from Left to Right
- ⇒ After proper setting of time in hours, minutes & seconds respectively for zeroes starting from left, press Tare key
- ⇒ Press the PRINT key to Change the format AM, PM & 24hrs.

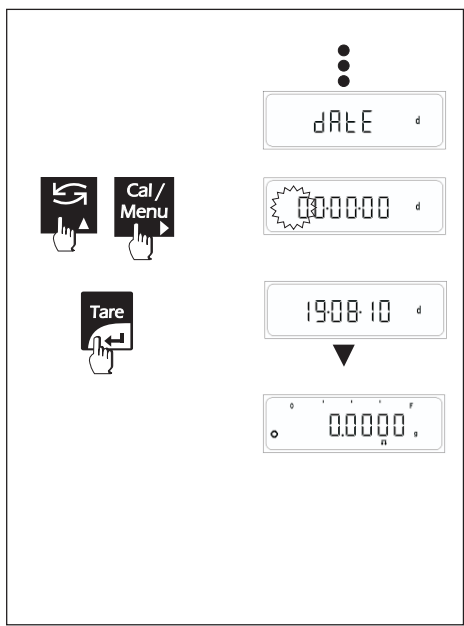

7.1.2 SET DATE

- ⇒ Press TARE key, "date" is display
- ⇒ Press TARE key, current date is displayed with first digit flashing. Flashing digit indicates that digit value or place can be changed.
- ⇒ Press TOGGLE key (▲) to change the value of the Flashing digit.
- ⇒ Press CAL key (▶) to shift the flashing digit from Left to Right
- ⇒ After proper setting of date in day, month & year respectively for zeroes starting from left,
- ⇒ Press TARE key to set the date

7.2 ID / LID Setting

In this menu user can set the identification number & Lot Identification number.

Operating Instructions

- ⇒ Press the PRINT key briefly when coming out from stand by or Power on mode.

7.2.1 SET ID

- ⇒ Last stored ID is displayed with first digit flashing. Flashing digit indicates that digit value or place can be changed.
- ⇒ Press TOGGLE key (▲) to change the value of the Flashing digit.
- ⇒ Press CAL key (▶) to shift the flashing digit from Left to Right
- ⇒ Press the TARE key to store ID Value

7.2.2 SET LID

- ⇒ Last stored LID is displayed with first digit flashing. Flashing digit indicates that digit value or place can be changed.
- ⇒ Press TOGGLE key (▲) to change the value of the Flashing digit.
- ⇒ Press CAL key (▶) to shift the flashing digit from Left to Right
- ⇒ Press the TARE key to store LID Value

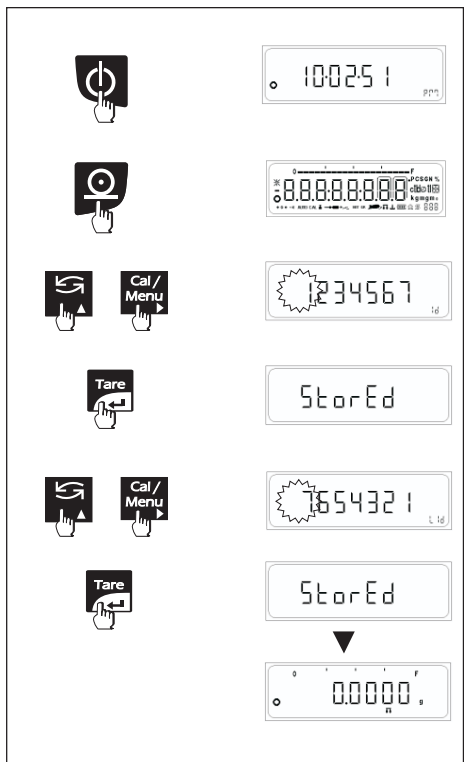

7.3 Auto Calibration

- ⇒ Auto Internal Calibration can be triggered automatically, by the following
- Time
 - Temperature
 - Power on Calibration

Operating Instruction

⇒ Press the CAL key briefly when coming out from stand by or Power on mode.

7.3.1 Auto CAL Time Settings

Select Auto CAL ON and press the <TARE> key, now press the <TARE> key when the Displays shows TIME to enter time settings.

User can set time value = 0.5 hrs.

User can set time value = 1 hrs.

User can set time value = 2 hrs.

User can set time value = 3 hrs.

User can set time value = 24 hrs.

User can set time value = OFF

Auto Cal triggered due to time will take place irrespective of cal test on or OFF

Note : The Above setting is available with balances with internal calibration.

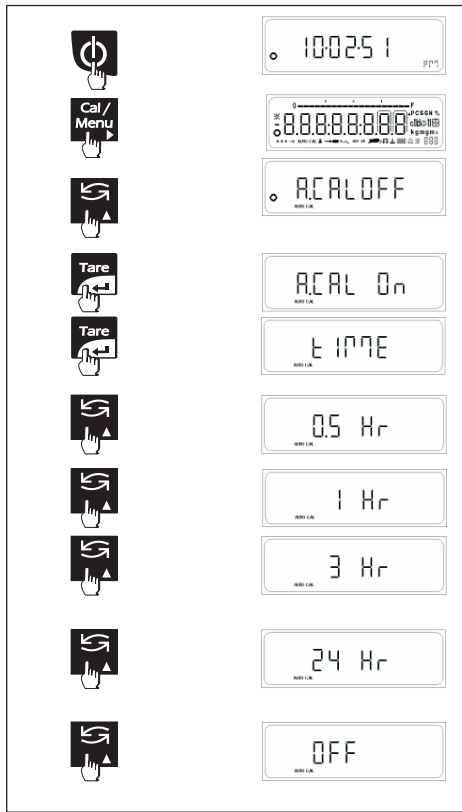

7.3.2 Auto CAL Temperature Settings

Select Auto CAL ON and press the <TARE> key, now press the <TOGGLE> key when the LCM displays TIME, press the <TARE> key to enter temperature settings.

User can set temp. value = 0.5°C.

User can set temp. value = 1°C.

User can set temp. value = 2°C.

User can set temp. value = 5°C.

User can set temp. value = OFF

Auto Cal triggered due to temp. change will take place irrespective of CAL test is On or off

Note : The Above setting is available with balances with internal calibration.

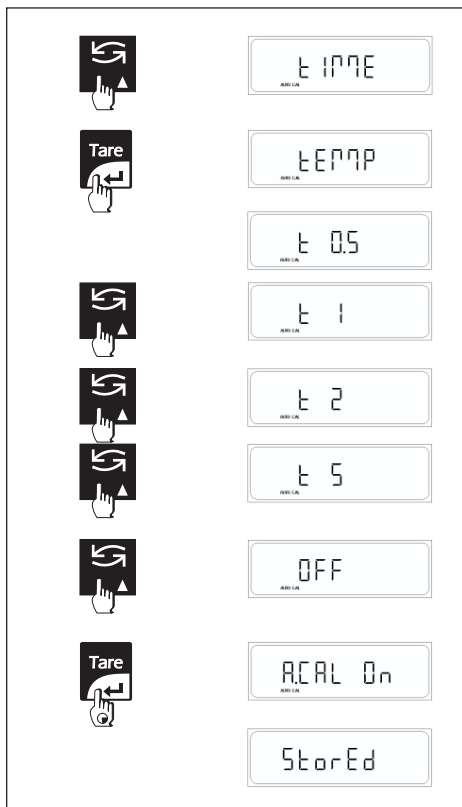

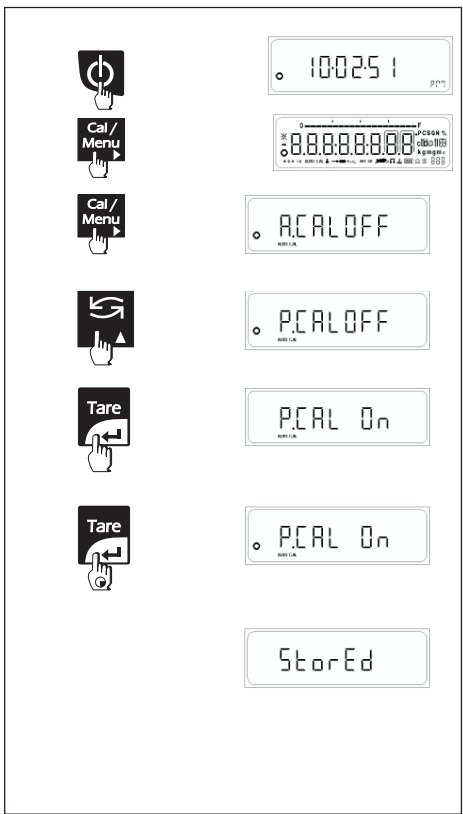

7.3.3 Power on Calibration

Press the CAL key when the LCM displays Auto CAL On or Off enter Power ON calibration options.

This setting enables the user to turn on or turn off power on calibration.

Power on calibration will take place every time the balance is powered on.

Power on Cal will take place irrespective of whether CAL Test is On or Off.

Note : The Above setting is available with balances with internal calibration.

7.4 Windows Direct Communication

The windows direct communication function enables you to send the data from the balance directly to any windows application program for e.g. Microsoft word, excel etc.

The printer settings in the user menu will be applicable to the windows direct communication also i.e. Data Transfer Mode, Baud rate, Parity, Stop Bit and GLP

The settings attributed to windows direct communication are

- Unit ON or OFF.
- Separator type ENTER or TAB.

To enable windows direct communication, make sure that you have turned it on from the windows side as well.

- ⇒ Enter control panel.
- ⇒ Open ACCESSIBILITY OPTIONS from control panel.
- ⇒ In the general tab turn on serial key option.
- ⇒ Set the baud rate and COM port from the settings option.

- ⇒ Click OK to accept the settings for serial key.
- ⇒ Click APPLY and then OK to save the Accessibility options.

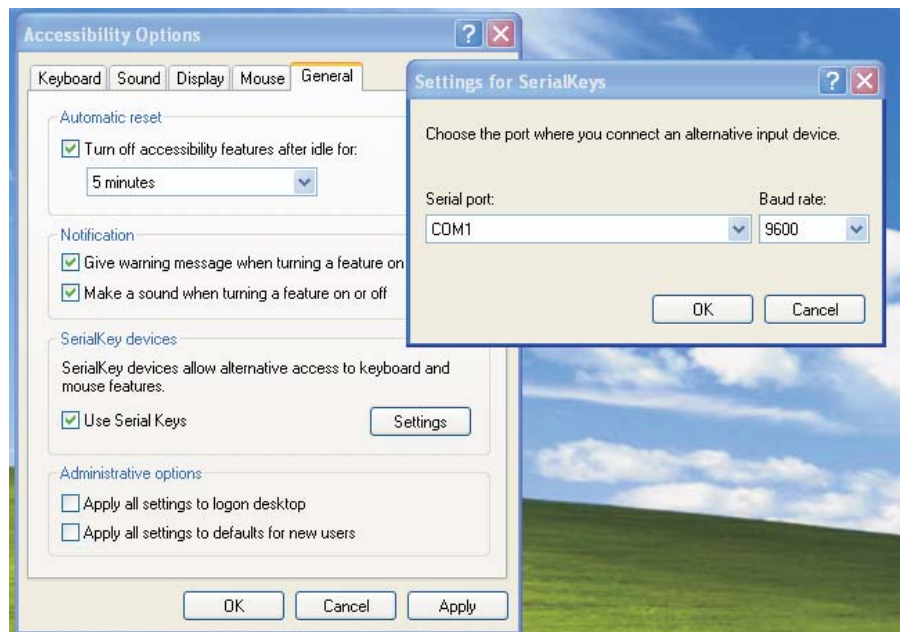

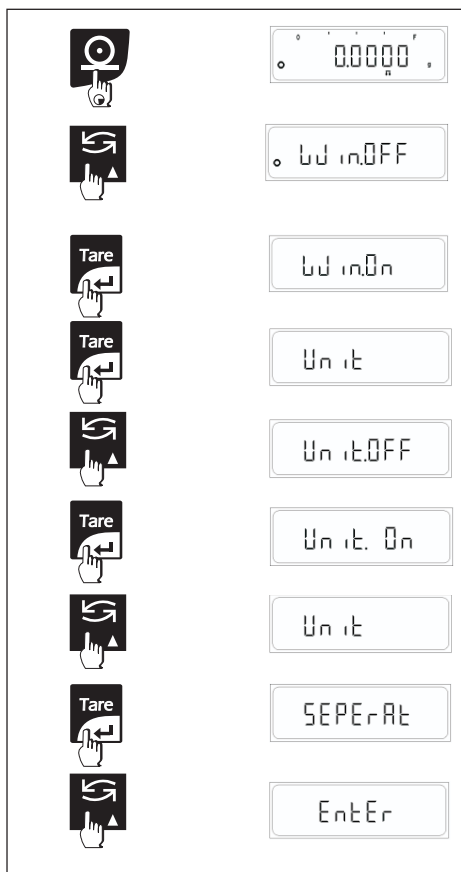

Windows direct communication settings (Balance Side)

- ⇒ Press and hold the <PRINT> key in simple weighing mode until the windows print menu is prompted.
- ⇒ Press the <TOGGLE> key briefly to change the windows option to ON of OFF. The default option is OFF.

Windows Unit settings

Select Windows print option as ON and press the <TARE> key, now press the <TARE> key when the LCM displays UNIT to enter unit settings.

User can set Unit option as ON (Along with the numerical value the unit will also be sent to windows).

User can set Unit option as OFF (Only the numerical value will be sent to windows and not the unit).

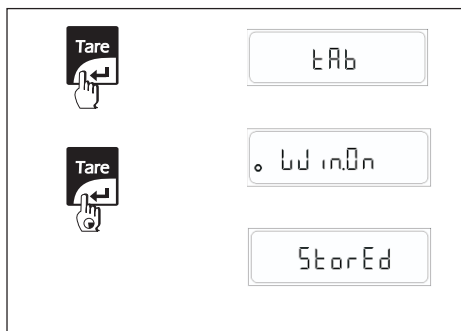

Windows Separator settings

Select Windows print option as ON and press the <TARE> key, now press the <TARE> key when the LCM displays 'Separat' to enter Separator settings.

User can set SEPERATOR option as ENTER (After every value printed on the windows side an ENTER command is given so every subsequent data will print on new line, in Excel every new data will be printed in new row).

User can set SEPERATOR option as TAB (After every value printed on the windows side a TAB command is given so every subsequent data will printed with tab, in Excel every new data will be printed in new column).

8. ISO/GLP-compliant Printout/Record

Features

You can have the parameters pertaining to the ambient weighing conditions printed before (GLP header) and after (GLP footer) the values of a weighing series. These parameters include:

GLP header:

- Date
- Time at beginning of measurement
- Balance manufacturer
- Balance model
- Balance serial number
- Software version number
- Identification number of the current sampling operation

GLP footer:

- Date
- Time at end of measurement
- Field for operator signature

The record is output to a CITIZEN data printer or a computer.

Settings

Set print option to request & GLP ON

Function Keys

Press the Print key to output header and first measured value.

End an Application:

Output GLP Footer : Press Cancel Key

End an application program Press Cancel key

The ISO/GLP-compliant record can contain the following lines:

-----		<i>Dotted line</i>
28-Jul-10	03:19PM	<i>Date / Time (beginning of measurement)</i>
	Citizen	<i>Balance Manufacturer</i>
Model	CX 220	<i>Balance Model</i>
Ser.no.	9223102	<i>Balance Serial Number</i>
Ver.no.	r0.1.5.3	<i>Software Version</i>
ID	1234567	<i>ID</i>
-----		<i>Dotted line</i>
LID:	1111111	<i>Lot ID</i>
nRef	170 pcs	<i>Counting : Reference Sample Quantity</i>
wRef	0.2945 g	<i>Counting : Reference Weight</i>
Qnt +	170 pcs	<i>Counting Result</i>
+	50.0650 g	<i>Weighing Result</i>
+	250.3250 ct	<i>Weighing Result</i>
-----		<i>Dotted line</i>
28-Jul-10	03:23PM	<i>Date / Time (end of measurement)</i>
Name:	<i>Name of Operator</i>
-----		<i>Dotted line</i>

The ISO/GLP-compliant record can contain the following lines:

-----		<i>Dotted line</i>
20-Jul-10	10:32AM	<i>Date / Time (beginning of measurement)</i>
	Citizen	<i>Balance Manufacturer</i>
Model	CX 220	<i>Balance Model</i>
Ser.no.	9223102	<i>Balance Serial Number</i>
Ver.no.	r0.1.5.3	<i>Software Version</i>
ID	1234567	<i>ID</i>
-----		<i>Dotted line</i>
Calibration:	External	<i>Calibration / Adjustment Mode</i>
W-ID	<i>Blank Line</i>
Temperature	32.905'C	<i>Weight ID</i>
Set	+ 200.0000 g	<i>Temperature</i>
Diff.	+ 0.1234 g	<i>Calibration Weight</i>
External Cal Done		<i>Diff. After Calibration</i>
Diff.	0.0000g	<i>Confirmation of Completed Calibration</i>
-----		<i>Blank Line</i>
20-Jul-10	10:32AM	<i>Difference from Nominal Value after Calibration</i>
Name:	<i>Dotted line</i>
-----		<i>Dotted line</i>

9. Data Interface

Purpose

Your balance is equipped with an interface port for connection to a computer or other peripheral device. You can use an on-line computer to change, start and/or monitor the functions of the balance and the application programs.

Features

- Type of interface: Serial interface
- Operating mode: Full duplex
- Standard: RS-232
- Transmission rates: 300; 600; 1,200; 2,400; 4,800; 9,600; 19,200 baud 57600
- Parity: Mark, space, odd, even, none
- Character format: 1 start bit, 8-bit ASCII, parity, 1 or 2 stop bits
- Handshake: None
- Data output format of the balance : 26 characters

Factory settings:

Transmission rate: 1,200 baud (9600)

Parity: Odd (none)

Stop bits: 1 stop bit

Handshake: None

Print manually/automatically: Manual at stability

Preparation

- See "Pin Assignments"

9.1 Output Format with 26 Characters

The following characters can be output, depending on the characters displayed on the balance :

Normal Operation

Position	1	2	3	4	5	6	7	8	9	10	11	12	13	14	15	16	17	18	19	20	21	22	23	24	25	26
	*	*	*	*	+	D	D	D	D	D	D	D	D	D	D	D	D	D	D	D	*	U	U	U	LF	CR
or	*	*	*	*	-	D	D	D	D	D	D	D	D	D	D	D	D	D	D	D	*	U	U	U	LF	CR
or	I	I	I	*	+	D	D	D	D	D	D	D	D	D	D	D	D	D	D	D	*	U	U	U	LF	CR

- | | |
|---------------------|-----------------------|
| * : Space | CR : Carriage Return |
| D : Digit or letter | LF : Line Feed |
| U : Unit Symbol | I : ID code Character |

Special Codes

Position	1	2	3	4	5	6	7	8	9	10	11	12	13	14	15	16	17	18	19	20	21	22	23	24	25	26
					-	-	-	-	-	-	-	O	L	-	-	-	-	-	-	-					LF	CR
or					-	-	-	-	-	-	-	U	L	-	-	-	-	-	-	-					LF	CR
or					-	-	-	-	-	-	-	O	r	-	-	-	-	-	-	-					LF	CR
					-	-	-	-	-	-	-	L	L	-	-	-	-	-	-	-					LF	CR
					-	-	-	-	-	-	-	H	H	-	-	-	-	-	-	-					LF	CR

- | | |
|----------------------|----------------------|
| OL : Space | UL : Carriage Return |
| Or : Digit or letter | LL : Line Feed |
| HH : Unit Symbol | |

Data Output Examples + 123.4567 g

Position	1	2	3	4	5	6	7	8	9	10	11	12	13	14	15	16	17	18	19	20	21	22	23	24	25	26
					+							1	2	3	.	4	5	6	7				g	LF	CR	
or					+						6	1	7	.	2	8	3	5				c	t	LF	CR	
or	N	1			+							2	0	.	0	0	0	0				g	LF	CR		
or	T	o	t		+							6	0	.	0	0	0	0				g	LF	CR		

Position 1 - 4 : ID code Character or Space
 Position 5 : Sign
 Position 6 - 20 : Weight with Decimal Point; leading zeros = space
 Position 21 : Space
 Position 22 - 24 : Unit Symbol or Space
 Position 25 : Line Feed
 Position 26 : Carriage Return

ID code		ID Code	
characters	Meaning	Characters	Meaning
nRef	Counting; Reference sample quantity	N1	Formulation, Totalization Net : N1
wRef	Piece Counting, Percentage Weighing : Reference weight	N	Formulation, Totalization Net N
Qnt	Piece Counting: Quantity	Tot	Formulation, Totalization : Total Weight
pRef	Weighing in percent: Reference percentage	Pur	density : Purity of Gold
Pct	Weighing in percent: Reference percentage	Den	Density : density of sample
Cnt	Animal weighing: No. of sub-weighing operations	Pip	Pipette Calibration
xNf	Animal weighing: Calculated average	Sta	Statistics : to obtain the statistics of the data

9.2 Data Input Format

You can connect a computer to your balance to send commands via the balance interface port to control balance functions and applications.

Format for commands

[Command Code	Data]
---	--------------	------	---

- [: it shows start of command frame.
- Command Code: it shows which functionality to be carried out for this command frame.
- Data: This field in frame is optional and it is intended to provide data information between Bi-directional communications.
-] : it shows end of command frame.

Commands

[W] : If host computer send this command to balance then balance will Send weight with current unit.

[T] : If host computer send this command then balance will do taring in balance. If stability is not achieved within 45 second then it comes to that specific feature till that time it shows "-----"on LCM.

9.3 Cabling Diagram

- For connecting a computer or other peripheral device to the balance using the RS-232 protocol and cables up to 15m (50 ft.) long.

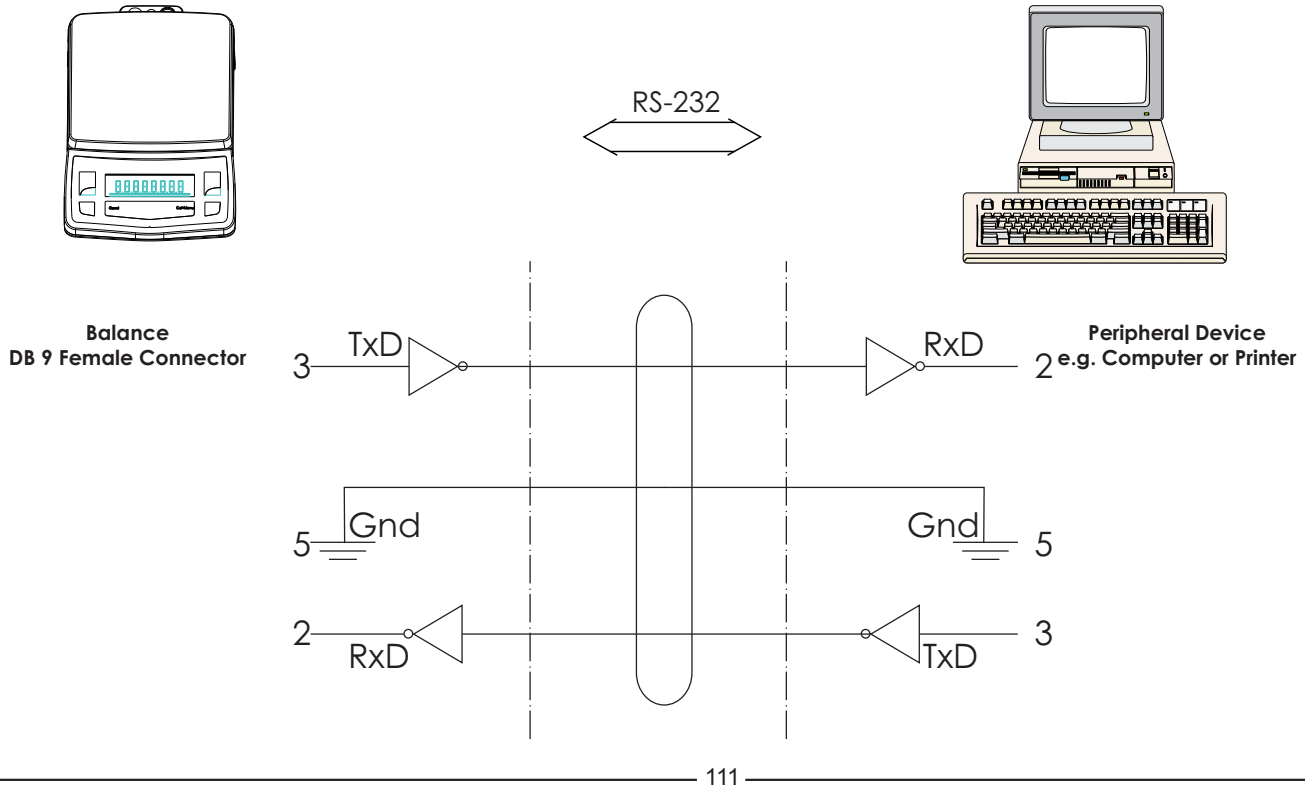

111

10. Error Codes

Display	Cause	Solution
--OL--	Overload	Remove excess weight from the weighing pan.
--UL--	Under load	<ul style="list-style-type: none"> Keep weighing Pan on Weighing Shaft. Check whether weighing pan is positioned properly.
Error 1	Weight set is to low for storing any reference at PCS, %, Custom Unit or Check Weighing.	Increase weight on the pan.
Error 2	While calibrating the scale, the load on the pan is more than 10% of the capacity. (During power on of the scale.)	Switch OFF the Balance and Switch ON again without any load on the pan.
Error 3	Calibration <ul style="list-style-type: none"> User does not keep any weight on the pan within 60 second. Weight load on the pan is not within the tolerance limit. 	<ul style="list-style-type: none"> Add the calibration weight on the pan when demanded by the balance Calibrate with the exact Calibration Weight.
Error 4	GLP is ON and user tries to enter in to the User Menu before the footer is printed.	Print the footer first, by pressing <CANCEL> key, and then access the USER MENU.
Error 6	Calibration Display shows any weight other than 0.00 and user tries to Calibrate the balance	Tare the balance or enter Calibration procedure when "0.00 g" is displayed.
Error 7	Incorrect value of TIME or DATE.	Enter proper value of TIME or DATE.

112

Display	Cause	Solution
Error 8	Last stored PRINT option is AUTO or AUTO LOAD or CONTINUOUS and user tries to set GLP ON from USER MENU.	Change the print option to Print on REQUEST and then turn GLP ON.
Error 9	RTC not operational.	Contact Citizen Service center.
Error29	Error 2 Calibration Error + RTC Error.	Contact Citizen Service center.
Error39	Error 3 Calibration Error + RTC Error.	Contact Citizen Service center.
The weight readout changes constantly	Unstable ambient conditions A foreign object is caught between the load plate and the balance/scale frame	Set up the balance/scale in another area Remove the foreign object
The weight readout is obviously wrong	The balance has not been calibrated / adjusted. The balance was not zeroed before weighing.	Calibrate / Adjust the balance. Tare or Zero the balance before weighing.

11. Care & Maintenance

Service

Regular servicing by a CITIZEN technician will extend the service life of your balance and ensure its continued weighing accuracy. CITIZEN can offer you service contracts, with your choice of regular maintenance intervals.

The optimum maintenance interval depends on the operating conditions at the place of installation and on the individual tolerance requirements.

Repairs

Repair work must be performed by trained service technicians. Any attempt by untrained persons to perform repairs may lead to hazards for the user.

Cleaning

- Unplug the DC adapter from the wall outlet (mains supply). If you have an interface cable connected to the balance/scale port, unplug it from the port.
- Make sure that no liquid enters the balance/scale housing
- Do not use any aggressive cleaning agents (solvents or similar agents)
- Clean the balance/scale using a piece of cloth which has been wet with a mild detergent (soap)
- After cleaning, wipe down the balance/scale with a soft, dry cloth

Cleaning Stainless Steel Surfaces

- Clean all stainless steel parts regularly. Remove the stainless steel weighing pan and thoroughly clean it separately. Use a damp cloth or sponge to clean any stainless steel parts on the scale. You can use any commercially available household cleaning agent that is suitable for use on stainless steel. Clean stainless steel surfaces by wiping them down. Then clean the weighing pan thoroughly, making sure to remove all residues. Use a damp cloth or sponge to wipe down any stainless steel parts on the scale again. Afterwards, allow the scale to dry. If desired, you can apply oil to the cleaned surfaces as additional protection.
- Do not use stainless steel cleaning agents that contain soda lye (caustic), acetic acid, hydrochloric acid, sulfuric acid or citric acid. The use of scrubbing sponges made of steel wool is not permitted. Solvents are permitted for use only on stainless steel parts.

Safety Inspection

If there is any indication that safe operation of the balance/scale with the DC adapter is no longer warranted:

- Turn off the power and disconnect the equipment from DC power immediately
- Lock the equipment in a secure place to ensure that it cannot be used for the time being.
- Safe operation of the balance/scale with the DC adapter is no longer ensured when:
 - There is visible damage to the DC adapter.
 - The DC adapter no longer functions properly.
 - The DC adapter has been stored for a relatively long period under unfavorable conditions.

LIMITED WARRANTY

CITIZEN products are warranted against defects in materials and workmanship from the date of delivery through the duration of the warranty period. During the warranty period Citizen will repair, or, at its option, replace any component (s) that proves to be defective at no charge, provided that the product is returned, freight prepaid, to CITIZEN.

This warranty does not apply if the product has been damaged by accident or misuse, exposed to radioactive or corrosive materials, has foreign material penetrating to the inside of the product, or as a result of service or modification by other than CITIZEN. In lieu of a properly returned warranty registration card, the warranty period shall begin on the date of shipment to the authorized dealer. No other express or implied warranty is given by Citizen Scale (i) Pvt. Ltd.

As warranty legislation differs from state to state and country to country, please contact citizen or your local CITIZEN dealer for further details.

CITIZEN service center will repair the product free of charge subject to terms & condition mentioned below.

TERMS & CONDITION

1. It covers only weighing balance purchased from authorized channel and does not cover accessories like Battery, Adaptor, RS232 cable, Pan, Pan support etc
2. It does not cover the product of which model and serial number has been altered, removed or defaced and / or is open by unauthorized person and found void sticker has been tampered.
3. This warranty is non-transferable and applicable only to first end user purchasing the product from authorized dealer.
4. For repair based on this warranty you need to hand over this product or send this product to address mentioned in warranty card in original packing, enclosing copy of this warranty card.'
5. Citizen Scale (I) Pvt. Ltd. shall not be liable for any consequential damages.

WARRANTY REGISTRATION



Citizen[®]
ISO 9001 : 2008 CERTIFIED

CITIZEN SCALES (I) PVT.LTD.

Citizen House, E2, Plot No. 11, WICEL Estate, Opp. Seepz Gate no. 1,
Andheri (E), Mumbai - 400 093. Maharashtra, India
e-mail :- service@citizenscales.com • web.: www.citizenscales.com
Tel. No. :- +91-22-4243 7700 • Fax :- +91-22-4243 7800

NAME :-

ADDRESS :-

.....

TEL NO. :-

MODEL NO. :-

SERIAL NO. :-

PURCHASE DATE :-

BRANCH / DISTRIBUTOR / DEALER CONTACT DETAILS

STAMP / SIGN

WARRANTY PERIOD :-

Owners Signature / Date

SEND YOUR WARRANTY CARD DULY FILL TO ABOVE ADDRESS FOR REGISTRATION

12. Dimensional Drawing

Analytical Balances
(CX / CY(0.1mg)Series
Balances)
Draft Shield High

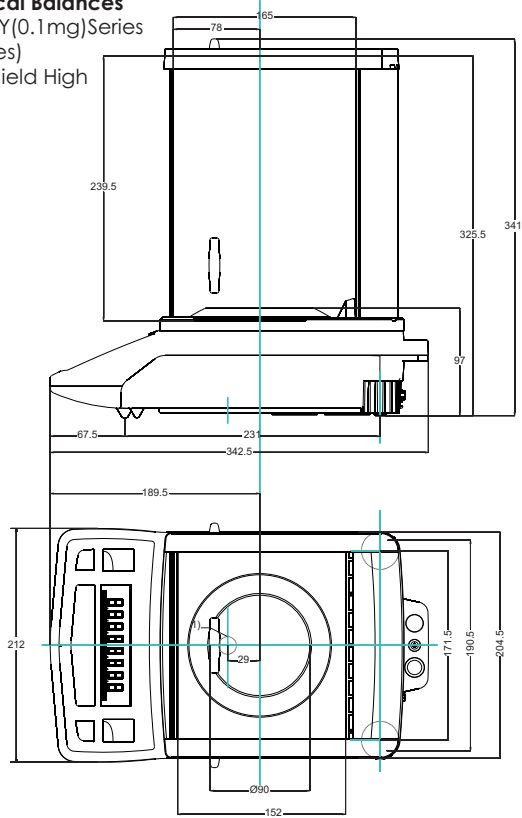

Carat Balances
(CT Series Balances)
Draft Shield Low

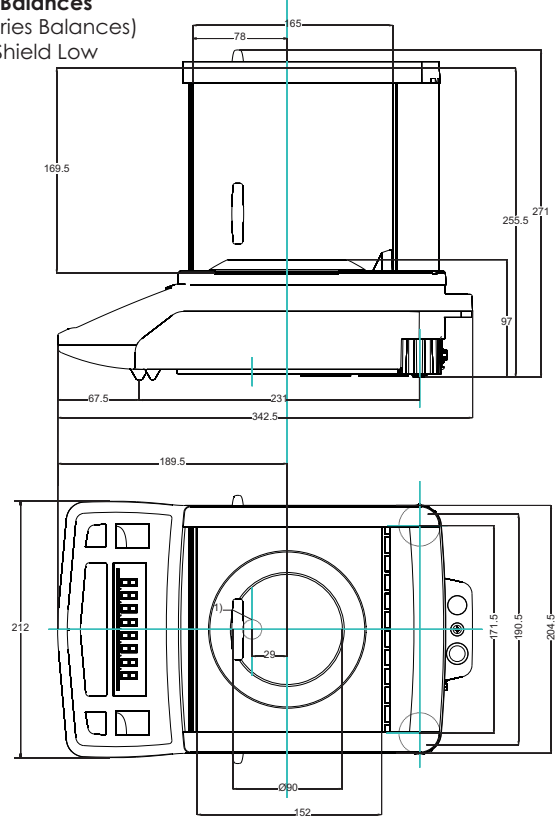

119

Top Loading Precision Balances
(CG Series Balances)
No Draft Shield

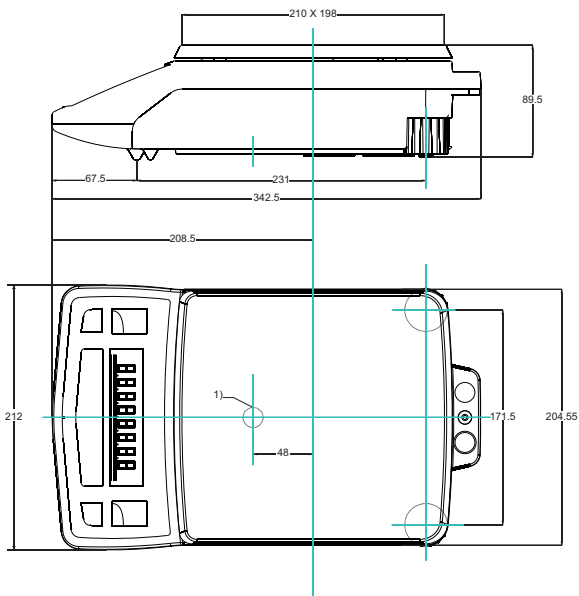

Precision Balances
(CY Series Balances)
Draft Shield Low

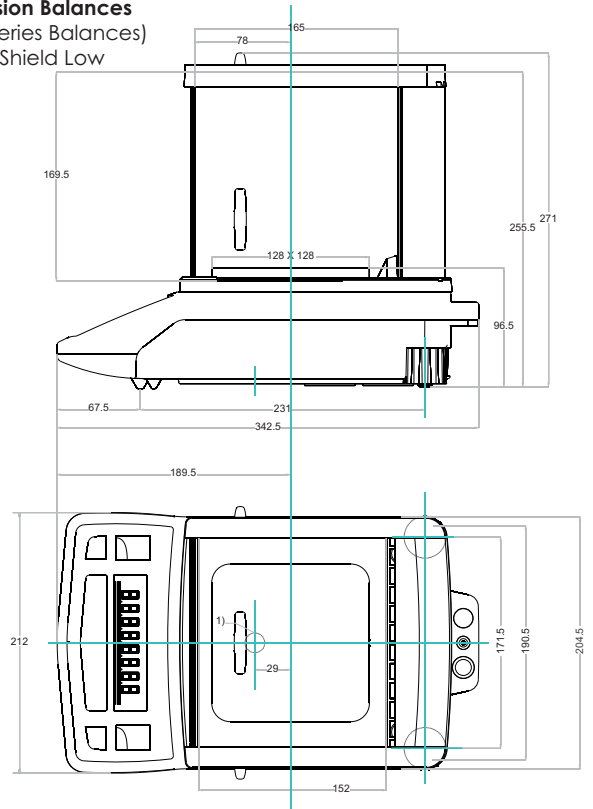

120

High Capacity Precision Balances
(SSH Series Balances)

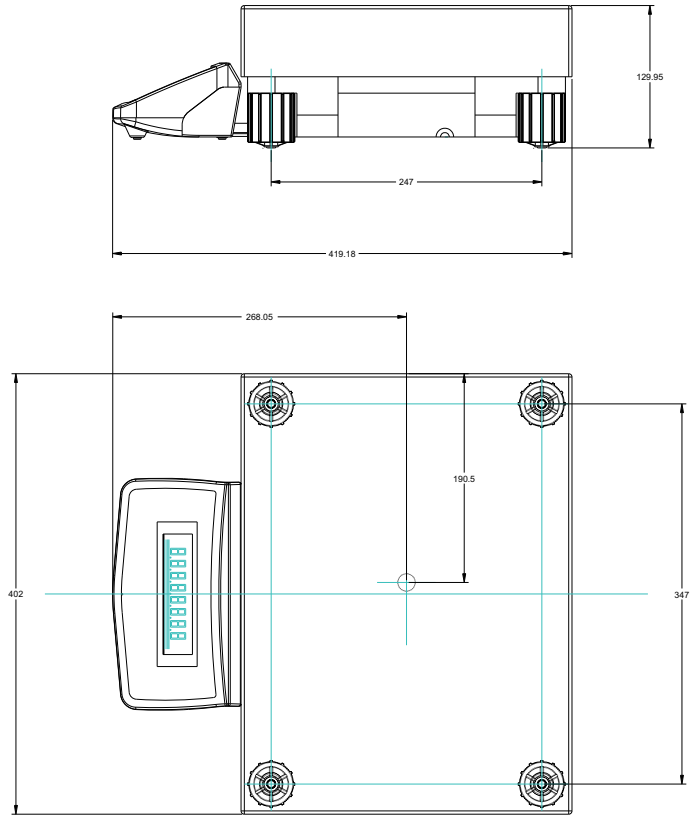

High Capacity Precision Balances
(CY Series Balance with wind shield)

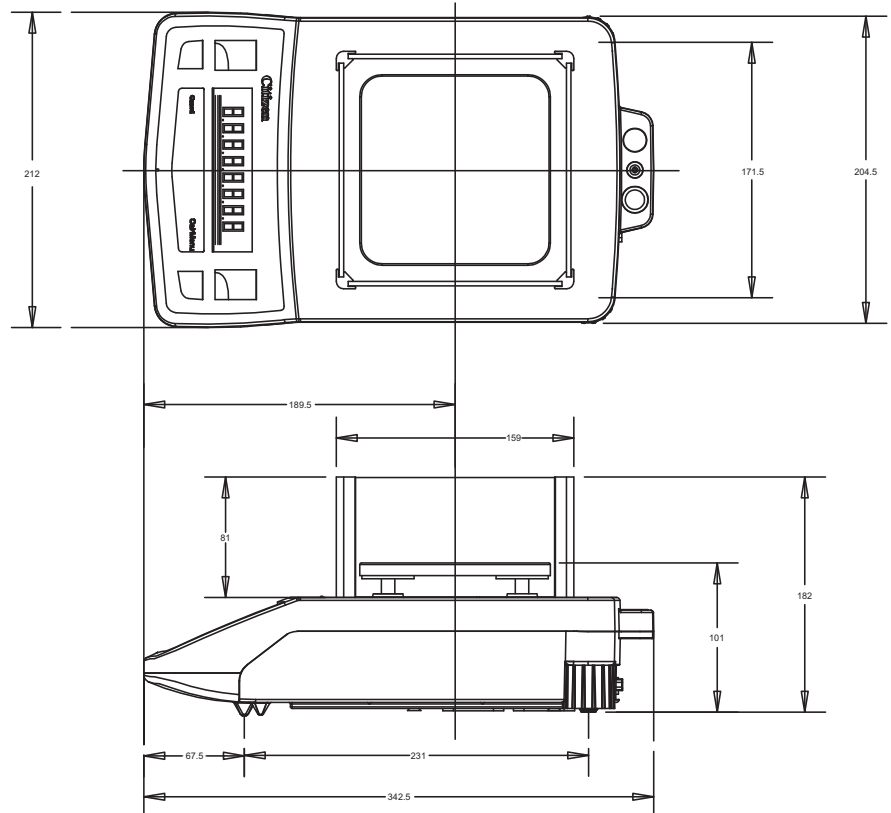

13. Specifications

Analytical Balances

Model		CX 301	CX 220	CX 120	CX 65	CX 54	CX 24
Weighing Capacity	g	301	220	120	65	51	21
Readability (d)	mg	0.1	0.1	0.1	0.1	0.1	0.1
Accuracy (e)	mg	1	1	1	1	1	1
Tare Range (Subtractive)	g	-301	-220	-120	-65	-51	-21
Repeatability (std. deviation)	<=mg	0.1	0.1	0.1	0.1	0.1	0.1
Linearity	<=mg	0.3	0.2	0.2	0.2	0.2	0.2
Weighing Class		I	I	I	I	II	II
Response time (average)	s	3 sec.					
Operating temperature range	°C	18° to 30°C	18° to 30°C	18° to 30°C	18° to 30°C	15° to 30°C	15° to 30°C
Calibration	°C	Internal	Internal	Internal	Internal	Internal	Internal
External calibration weight (of at least accuracy class...)	g	200 (E2)	100 (E2)	50 (E2)	25 (E2)	25 (E2)	10 (E2)
Net Weight, approx.	kg	8kg					
Pan size	mm	90 Ø					
Weighing chamber height	mm	228.5					
Dimensions (W x D x H)	mm	342.5 x 212 x 341					
DC power source / Power requirements	V~	DC Adapter, input 100 ~ 240 0.8A output 13V / 1.5A					⊕ ← ⊖
Frequency	Hz	50 / 60Hz					
Power consumption (average)	VA	maximum 18; typical 9					
Selectable weight units		gram, kilogram, pound, ounce, troy ounce, grain, pennyweight carat, Milligram, momme, mesghal, Hong Kong taels, Singapore taels Taiwan taels, baht					
Built-in-interface		RS-232					
Format		1 start bit, 8-bit ASCII, parity, 1 or 2 stop bits					
Parity		Mark, Space, Odd, even, none					
Transmission rates :		300; 600; 1200; 2400; 4800; 9600; 19200; 57600 baud					
Handshake mode		None					

123

Analytical Balances

Model		CY 204	CY 104	CY 64	CY 54	CY 24	
Weighing Capacity	g	220	120	61	51	21	
Readability (d)	mg	0.1	0.1	0.1	0.1	0.1	
Accuracy (e)	mg	1	1	1	1	1	
Tare Range (Subtractive)	g	-220	-120	-61	-51	-21	
Repeatability (std. deviation)	<=mg	0.1	0.1	0.1	0.1	0.1	
Linearity	<=mg	0.2	0.2	0.2	0.2	0.2	
Weighing Class		I	I	I	II	II	
Response time (average)	s	3 sec.					
Operating temperature range	°C	18° to 30°C	18° to 30°C	18° to 30°C	15° to 30°C	15° to 30°C	
Calibration	°C	External	External	External	External	External	
External calibration weight (of at least accuracy class...)		100 (E2)	50 (E2)	25 (E2)	25 (E2)	10 (E2)	
Net Weight, approx.	g	8kg					
Pan size	kg	90 Ø					
Weighing chamber height	mm	228.5					
Dimensions (W x D x H)	mm	342.5 x 212 x 341					
DC power source / Power requirements	mm	DC Adapter, input 100 ~ 240 0.8A output 13V / 1.5A					⊕ ← ⊖
Frequency	V~	50 / 60Hz					
Power consumption (average)	Hz	maximum 18; typical 9					
Selectable weight units	VA	gram, kilogram, pound, ounce, troy ounce, grain, pennyweight carat, Milligram, momme, mesghal, Hong Kong taels, Singapore taels Taiwan taels, baht					
Built-in-interface		RS-232					
Format		1 start bit, 8-bit ASCII, parity, 1 or 2 stop bits					
Parity		Mark, Space, Odd, even, none					
Transmission rates :		300; 600; 1200; 2400; 4800; 9600; 19200; 57600 baud					
Handshake mode		None					

124

Precision Balances

Model		CY 120	CY 220	CY 320	CY 360	CY 420	CY 510	CY 720	CY 1003
Weighing Capacity	g	120	220	320	360	420	510	720	1000
Readability (d)	g	0.001	0.001	0.001	0.001	0.001	0.001	0.001	0.001
Accuracy (e)	g	0.01	0.01	0.01	0.01	0.01	0.01	0.01	0.01
Tare Range (Subtractive)	g	-120	-220	-320	-360	-420	-510	-720	-1000
Repeatability (std. deviation)	<=g	0.001	0.001	0.001	0.001	0.001	0.002	0.002	0.002
Linearity	<=g	0.002	0.002	0.002	0.002	0.002	0.003	0.003	0.003
Weighing Class		II	II	II	II	II	II	I	I
Response time (average)	s	2 - 3 sec.							
Operating temperature range	°C	15° to 30°C	15° to 30°C	15° to 30°C	15° to 30°C	15° to 30°C	15° to 30°C	18° to 30°C	18° to 30°C
Calibration	°C	External	External	External	External	External	External	External	External
External cal. wt. (of at least accuracy class..)	g	50 (F1)	100 (F1)	200 (F1)	200 (F1)	200 (F1)	300 (F1)	500 (F1)	500 (F1)
Net Weight, approx.	kg	7.5kg							
Pan size	mm	128 x 128							
Weighing chamber height with draftshield	mm	158.5							
Weighing chamber height with Windshield	mm	81							
Dimensions (W x D x H) with draftshield	mm	342.5 x 212 x 271							
Dimensions (W x D x H) with windshield	mm	342.5 x 212 x 193.5							
DC power source / Power requirements	V~	DC Adapter, input 100 ~ 240 0.8A output 13V / 1.5A						⊕ ⊖ ⊖	
Frequency	Hz	50 / 60Hz							
Power consumption (average)	VA	maximum 18; typical 9							
Selectable weight units		gram, kilogram, pound, ounce, troy ounce, grain, pennyweight carat, Milligram, momme, mesghal, Hong Kong taels, Singapore taels Taiwan taels, baht							
Built-in-interface		RS-232							
Format		1 start bit, 8-bit ASCII, parity, 1 or 2 stop bits							
Parity		Mark, Space, Odd, even, none							
Transmission rates :		300; 600; 1200; 2400; 4800; 9600; 19200; 57600 baud							
Handshake mode		None							

125

Precision Balances

Model		CY 120C	CY 220C	CY 320C	CY 360C	CY 420C	CY 510C	CY 1003C	
Weighing Capacity	g	120	220	320	360	420	510	1000	
Readability (d)	g	0.001	0.001	0.001	0.001	0.001	0.001	0.001	
Accuracy (e)	g	0.01	0.01	0.01	0.01	0.01	0.01	0.01	
Tare Range (Subtractive)	g	-120	-220	-320	-360	-420	-510	-1000	
Repeatability (std. deviation)	<=g	0.001	0.001	0.001	0.001	0.001	0.002	0.002	
Linearity	<=g	0.002	0.002	0.002	0.002	0.002	0.003	0.003	
Weighing Class		II	II	II	II	II	II	I	
Response time (average)	s	2 - 3 sec.							
Operating temperature range	°C	15° to 30°C	15° to 30°C	15° to 30°C	15° to 30°C	15° to 30°C	15° to 30°C	18° to 30°C	
Calibration	°C	Internal	Internal	Internal	Internal	Internal	Internal	Internal	
External cal. wt. (of at least accuracy class..)	g	50 (F1)	100 (F1)	200 (F1)	200 (F1)	200 (F1)	300 (F1)	500 (F1)	
Net Weight, approx.	kg	7.8kg							
Pan size	mm	128 x 128							
Weighing chamber height with draftshield	mm	158.5							
Weighing chamber height with Windshield	mm	81							
Dimensions (W x D x H) with draftshield	mm	342.5 x 212 x 271							
Dimensions (W x D x H) with windshield	mm	342.5 x 212 x 193.5							
DC power source / Power requirements	V~	DC Adapter, input 100 ~ 240 0.8A output 13V / 1.5A						⊕ ⊖ ⊖	
Frequency	Hz	50 / 60Hz							
Power consumption (average)	VA	maximum 18; typical 9							
Selectable weight units		gram, kilogram, pound, ounce, troy ounce, grain, pennyweight carat, Milligram, momme, mesghal, Hong Kong taels, Singapore taels Taiwan taels, baht							
Built-in-interface		RS-232							
Format		1 start bit, 8-bit ASCII, parity, 1 or 2 stop bits							
Parity		Mark, Space, Odd, even, none							
Transmission rates :		300; 600; 1200; 2400; 4800; 9600; 19200; 57600 baud							
Handshake mode		None							

126

Top Loading Precision Balances

Model		CG 312	CG 612	CG 613	CG 1202
Weighing Capacity	g	310	610	610	1200
Readability (d)	g	0.01	0.01	0.01	0.01
Accuracy (e)	g	0.1	0.1	0.01	0.1
Tare Range (Subtractive)	g	-310	-610	-610	-1200
Repeatability (std. deviation)	<=g	0.01	0.01	0.01	0.01
Linearity	<=g	0.02	0.02	0.02	0.02
Weighing Class		III	III	II	II
Response time (average)	s	2 - 3 sec.			
Operating temperature range	°C	15° to 45°C	15° to 45°C	15° to 30°C	15° to 30°C
Calibration		External	External	External	External
External cal. wt. (of at least accuracy class..)	g	200 (F1)	300 (F1)	300 (F1)	1000 (F1)
Net Weight, approx.	kg	5.5kg			
Pan size	mm	198 x 205	198 x 205	128 x 128	198 x 205
Dimensions (W x D x H)	mm	342.5 x 212 x 89.5			
DC power source / Power requirements	V~	DC Adapter, input 100 ~ 240 0.8A output 13V / 1.5A			⊕ ← ⊖
Frequency	Hz	50 / 60Hz			
Power consumption (average)	VA	maximum 18; typical 9			
Selectable weight units		gram, kilogram, pound, ounce, troy ounce, grain, pennyweight carat, Milligram, momme, mesghal, Hong Kong taels, Singapore taels Taiwan taels, baht			
Built-in-interface		RS-232			
Format		1 start bit, 8-bit ASCII, parity, 1 or 2 stop bits			
Parity		Mark, Space, Odd, even, none			
Transmission rates :		300; 600; 1200; 2400; 4800; 9600; 19200; 57600 baud			
Handshake mode		None			

Top Loading Precision Balances

Model		CG 2202	CG 3102	CG 4102	CG 6102	CG 2102DR
Weighing Capacity	g	2200	3100	4100	6100	200 / 2100
Readability (d)	g	0.01	0.01	0.01	0.01	0.001 / 0.01
Accuracy (e)	g	0.1	0.1	0.1	0.1	0.01 / 0.1
Tare Range (Subtractive)	g	-2200	-3100	-4100	-6100	-200 / 2100
Repeatability (std. deviation)	<=g	0.01	0.01	0.01	0.02	0.002 / 0.02
Linearity	<=g	0.02	0.02	0.02	0.03	0.003 / 0.03
Weighing Class		II	II	II	I	I
Response time (average)	s	2 - 3 sec.				
Operating temperature range	°C	15° to 30°C	15° to 30°C	15° to 30°C	18° to 30°C	18° to 30°C
Calibration		External	External	External	External	External
External cal. wt. (of at least accuracy class..)	g	1000 (F1)	1500 (F1)	2000 (F1)	4000 (F1)	1000 (F1)
Net Weight, approx.	kg	5.5kg				
Pan size	mm	198 x 205	198 x 205	198 x 205	198 x 205	128 x 128
Dimensions (W x D x H)	mm	342.5 x 212 x 89.5				342.5 x 212 x 271
DC power source / Power requirements	V~	DC Adapter, input 100 ~ 240 0.8A output 13V / 1.5A			⊕ ← ⊖	
Frequency	Hz	50 / 60Hz				
Power consumption (average)	VA	maximum 18; typical 9				
Selectable weight units		gram, kilogram, pound, ounce, troy ounce, grain, pennyweight carat, Milligram, momme, mesghal, Hong Kong taels, Singapore taels Taiwan taels, baht				
Built-in-interface		RS-232				
Format		1 start bit, 8-bit ASCII, parity, 1 or 2 stop bits				
Parity		Mark, Space, Odd, even, none				
Transmission rates :		300; 600; 1200; 2400; 4800; 9600; 19200; 57600 baud				
Handshake mode		None				

Top Loading Precision Balances

Model		CG 312C	CG 612C	CG1202C	CG 2202C	CG3102C	CG 4102C	CG 6102C	
Weighing Capacity	g	310	610	1200	2200	3100	4100	6100	
Readability (d)	g	0.01	0.01	0.01	0.01	0.01	0.01	0.01	
Accuracy (e)	g	0.1	0.1	0.1	0.1	0.1	0.1	0.1	
Tare Range (Subtractive)	g	-310	-610	-1200	-2200	-3100	-4100	-6100	
Repeatability (std. deviation)	<=g	0.01	0.01	0.01	0.01	0.01	0.01	0.02	
Linearity	<=g	0.02	0.02	0.02	0.02	0.02	0.02	0.03	
Weighing Class		III	III	II	II	II	II	I	
Response time (average)	s	2 - 3 sec.							
Operating temperature range	°C	15° to 45°C	15° to 45°C	15° to 30°C	15° to 30°C	15° to 30°C	15° to 30°C	18° to 30°C	
Calibration		Internal	Internal	Internal	Internal	Internal	Internal	Internal	
External cal. wt. (of at least accuracy class..)	g	200 (F1)	300 (F1)	1000 (F1)	1000 (F1)	1500 (F1)	2000 (F1)	4000 (F1)	
Net Weight, approx.	kg	6kg							
Pan size	mm	198 x 205							
Dimensions (W x D x H)	mm	342.5 x 212 x 89.5							
DC power source / Power requirements	V~	DC Adapter, input 100 ~ 240 0.8A output 13V / 1.5A					⊕—⊖		
Frequency	Hz	50 / 60Hz							
Power consumption (average)	VA	maximum 18; typical 9							
Selectable weight units		gram, kilogram, pound, ounce, troy ounce, grain, pennyweight carat, Milligram, momme, mesghal, Hong Kong taels, Singapore taels Taiwan taels, baht							
Built-in-interface		RS-232							
Format		1 start bit, 8-bit ASCII, parity, 1 or 2 stop bits							
Parity		Mark, Space, Odd, even, none							
Transmission rates :		300; 600; 1200; 2400; 4800; 9600; 19200; 57600 baud							
Handshake mode		None							

High Capacity Precision Balances

Model		SSH 96	SSH 95	SSH 94	SSH 94H
Weighing Capacity	Kg	10	15	20	25
Readability (d)	g	0.01	0.1	0.1	0.1
Accuracy (e)	g	0.1	1	1	1
Tare Range (Subtractive)	Kg	-10	-15	-20	-25
Repeatability (std. deviation)	<=g	0.02	0.1	0.1	0.1
Linearity	<=g	0.04	0.2	0.2	0.2
Weighing Class		II	II	II	II
Response time (average)	s	2 - 3 sec.			
Operating temperature range	°C	15° to 30°C	15° to 30°C	15° to 30°C	15° to 30°C
Calibration		External	External	External	External
External calibration weight (of at least accuracy class...)	Kg	5 (E2)	10 (F1)	10 (F1)	15 (F1)
Net Weight, approx.	kg	15kg			
Pan size	mm	400 x 300			
Dimensions (W x D x H)	mm	517 x 302 x 130			
DC power source / Power requirements	V~	DC Adapter, input 100 ~ 240 0.8A output 13V / 1.5A			⊕—⊖
Frequency	Hz	50 / 60Hz			
Power consumption (average)	VA	maximum 18; typical 9			
Selectable weight units		gram, kilogram, pound, ounce, troy ounce, grain, pennyweight carat, Milligram, momme, mesghal, Hong Kong taels, Singapore taels Taiwan taels, baht			
Built-in-interface		RS-232			
Format		1 start bit, 8-bit ASCII, parity, 1 or 2 stop bits			
Parity		Mark, Space, Odd, even, none			
Transmission rates :		300; 600; 1200; 2400; 4800; 9600; 19200; 57600 baud			
Handshake mode		None			

High Capacity Precision Balances

Model		SSH 93	SSH 92	SSH 91	SSH 90
Weighing Capacity	Kg	35	50	60	100
Readability (d)	g	0.1	1	1	1
Accuracy (e)	g	1	10	10	10
Tare Range (Subtractive)	Kg	-35	-50	-60	-100
Repeatability (std. deviation)	<=g	0.1	1	1	1
Linearity	<=g	0.2	2	2	2
Weighing Class		II	III	III	III
Response time (average)	s	2 - 3 sec.			
Operating temperature range	°C	15° to 30°C	15° to 45°C	15° to 45°C	15° to 45°C
Calibration		External	External	External	External
External calibration weight (of at least accuracy class...)	Kg	15 (F1)	25 (F1)	30 (F1)	50 (F1)
Net Weight, approx.	kg	15kg			
Pan size	mm	400 x 300			
Dimensions (W x D x H)	mm	517 x 302 x 130			
DC power source / Power requirements	V~	DC Adapter, input 100 ~ 240 0.8A output 13V / 1.5A ⊕←⊖			
Frequency	Hz	50 / 60Hz			
Power consumption (average)	VA	maximum 18; typical 9			
Selectable weight units		gram, kilogram, pound, ounce, troy ounce, grain, pennyweight carat, Milligram, momme, mesghal, Hong Kong taels, Singapore taels Taiwan taels, baht			
Built-in-interface		RS-232			
Format		1 start bit, 8-bit ASCII, parity, 1 or 2 stop bits			
Parity		Mark, Space, Odd, even, none			
Transmission rates :		300; 600; 1200; 2400; 4800; 9600; 19200; 57600 baud			
Handshake mode		None			

Carat Balances

Model		CT 103	CT 253	CT 603	CT 1103	CT 1603
Weighing Capacity	ct	101	250	600	1100	1600
Readability (d)	ct	0.001	0.001	0.001	0.001	0.001
Accuracy (e)	ct	0.01	0.01	0.01	0.01	0.01
Tare Range (Subtractive)	ct	-101	-250	-600	-1100	-1600
Repeatability (std. deviation)	<=ct	0.001	0.001	0.001	0.001	0.002
Linearity	<=ct	0.002	0.002	0.002	0.002	0.003
Weighing Class		II	II	I	I	I
Response time (average)	s	3 sec.				
Operating temperature range	°C	15° to 30°C	15° to 30°C	18° to 30°C	18° to 30°C	18° to 30°C
Calibration		External	External	External	External	External
External calibration weight (of at least accuracy class...)		10 (F1)	25 (F1)	50 (F1)	100 (F1)	200 (F1)
Net Weight, approx.	kg	7.5				
Pan size	mm	90 Ø				
Weighing chamber height	mm	158.5				
Dimensions (W x D x H)	mm	342.5 x 212 x 271				
DC power source / Power requirements	V~	DC Adapter, input 100 ~ 240 0.8A output 13V / 1.5A				⊕←⊖
Frequency	Hz	50 / 60Hz				
Power consumption (average)	VA	maximum 18; typical 9				
Selectable weight units		gram, kilogram, pound, ounce, troy ounce, grain, pennyweight carat, Milligram, momme, mesghal, Hong Kong taels, Singapore taels Taiwan taels, baht				
Built-in-interface		RS-232				
Format		1 start bit, 8-bit ASCII, parity, 1 or 2 stop bits				
Parity		Mark, Space, Odd, even, none				
Transmission rates :		300; 600; 1200; 2400; 4800; 9600; 19200; 57600 baud				
Handshake mode		None				

Carat Balances

Model		CT 103C	CT 253C	CT 603C	CT 1103C	CT 1603C
Weighing Capacity	ct	101	250	600	1100	1600
Readability (d)	ct	0.001	0.001	0.001	0.001	0.001
Accuracy (e)	ct	0.01	0.01	0.01	0.01	0.01
Tare Range (Subtractive)	ct	-101	-250	-600	-1100	-1600
Repeatability (std. deviation)	<=ct	0.001	0.001	0.001	0.001	0.002
Linearity	<=ct	0.002	0.002	0.002	0.002	0.003
Weighing Class		II	II	I	I	I
Response time (average)	s	3 sec.				
Operating temperature range	°C	15° to 30°C	15° to 30°C	18° to 30°C	18° to 30°C	18° to 30°C
Calibration		Internal	Internal	Internal	Internal	Internal
External calibration weight (of at least accuracy class...)		10 (F1)	25 (F1)	50 (F1)	100 (F1)	200 (F1)
Net Weight, approx.	kg	7.8kg				
Pan size	mm	90 Ø				
Weighing chamber height	mm	158.5				
Dimensions (W x D x H)	mm	342.5 x 212 x 271				
DC power source / Power requirements	mm	DC Adapter, input 100 ~ 240 0.8A output 13V / 1.5A				
Frequency	V~	50 / 60Hz				
Power consumption (average)	Hz	maximum 18; typical 9				
Selectable weight units	VA	gram, kilogram, pound, ounce, troy ounce, grain, pennyweight carat, Milligram, momme, mesghal, Hong Kong tales, Singapore tael Taiwan tales, baht				
Built-in-interface		RS-232				
Format		1 start bit, 8-bit ASCII, parity, 1 or 2 stop bits				
Parity		Mark, Space, Odd, even, none				
Transmission rates :		300; 600; 1200; 2400; 4800; 9600; 19200; 57600 baud				
Handshake mode		None				

14. Accessories (Option)

Statistical Printer "CPR 02"

with Date / Time & Statistics

Remote Display "SRD01"

Calibration Weights

(F1) (ERTL, F2 with certificate) for further details, contact CITIZEN Dealers.

USB Interface

Density Kit "CDK 01"

For determination of solids for determination of liquids with displacement body

Antitheft device

Cable and lock (for all models)

Dust Cover