

MY SCALE

Technical Manual



MS715 / MS715-SS

Weighing Indicator

CONTENTS

1. SPECIFICATION.....	2
2. INTRODUCTION.....	3
3. INSTALLATION.....	4
Precautions	4
Parts.....	4
Installation.....	5
4. KEYS DESCRIPTION.....	6
Key Board.....	6
Secondary functions of the keys.....	7
Display.....	7
5. OPERATION.....	8
5.1. Basic Operation.....	8
1. Power On /Off.....	8
2. Zero.....	8
3. Tare.....	8
4. Select Unit.....	8
5.2. Check Weighing.....	9
5.2.1. Set Limits.....	9
5.2.2. Set Check Weighing.....	9
5.3. Accumulation.....	10
5.3.1. Memory Recall.....	10
5.3.2. Memory Clear.....	10
5.3.3. Automatically Accumulation.....	10
5.4. Parts Counting.....	11
5.5. Animal Weighing.....	11
5.6. Key Board Lock.....	11
5.7. Set Auto Power Off.....	12
5.8. Set Back Light.....	13
6. PARAMETERS.....	14
7. CALIBRATION.....	16
8. RS-232 OUTPUT.....	17
8.1. Specifications.....	17
8.2. Connector.....	17
RS-232 Output.....	17
Check weighing Output.....	17
8.3. Continues output protocol.....	17
9. DRAWING.....	19
9.1. BW Drawing.....	19
9.2. BW Parts List.....	20
9.3. BWS Drawing.....	21
9.4. BWS Parts List.....	22

PRECAUTIONS

	 WARNING
	DISCONNECT ALL POWER TO THIS UNIT BEFORE INSTALLING, CLEANING, OR SERVICING. FAILURE TO DO SO COULD RESULT IN BODILY HARM OR DAMAGE THE UNIT.

 CAUTION
<ul style="list-style-type: none">• Permit only qualified persons to service the instrument• Before connecting or disconnecting any components, remove the power.• Failure to observe these precautions bodily harm or damage to or destruction of the equipment.



- The weighing indicator is a precision electronic instrument, handle it carefully.
- Do not install the scale in direct sunlight.
- Verify the local voltage and receptacle type are correct for the scale.
- Only use original adaptor, other could cause damage to the scale.
- Pluggable equipment must be installed near an easily accessible socket outlet.
- Avoid unstable power sources. Do not use near large users of electricity such as welding equipment or large motors.
- Avoid sudden temperature changes, vibration, wind and water.
- Avoid heavy RF noise.
- Keep the indicator clean

1. SPECIFICATION

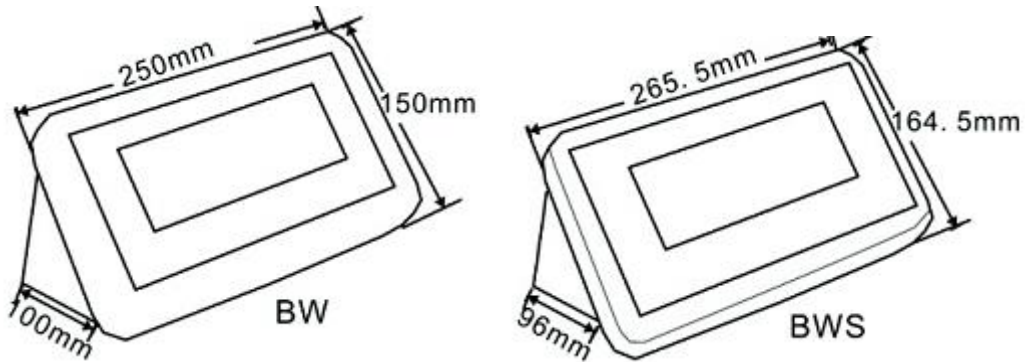

Model	BW	BW-E	BWS	BWS-E
Display	52mm LCD	1.2" LED	52mm LCD	1.2" LED
Housing	ABS Plastic		SST	
Operating Temperature	-10°C - 40°C / 14°F - 104°F			
Resolution	1/6000 (OIML Approved)			
Key Pad	7 Keys			
Power	AC Adaptor (12V/500mA)/ Battery (6V/4Ah)			
Calibration	Automatic External			
Interface	RS-232 Output Optional			
Load cell drive Voltage	Max: 5V/150mA			
Load Cells	Up to 4 load cell			
ADC	Sigma Delta			
ADC Update	≤1/10 second			
Stabilization Time	One seconds typical			

2. INTRODUCTION

- The BW series weighing indicator that amplifies signals from a load cell, converts it to digital data and displays it as a mass value.
- It is suitable for general weighing or more specialized applications such as check weighing, animal weighing and accumulation applications.
- It can connect the indicator to a printer or a PC.
- Large LCD with white LED back light displays

3. INSTALLATION

Unpacking

When you receive the scale, inspect it to make sure that it is not damaged and that all the parts are included:

- Remove the Indicator from the carton.
- Remove the protective covering. Store the packaging and to use if you need to transport the scale later.
- Inspect the indicator for damage.
- Make sure all components are included.
 1. Indicator
 2. Adaptor
 3. Manual
 4. Indicator holder (Optional)
 5. Load cell Output connector (Optional)
 6. RS-232 Output Connector (Optional)

Parts Description



Installation





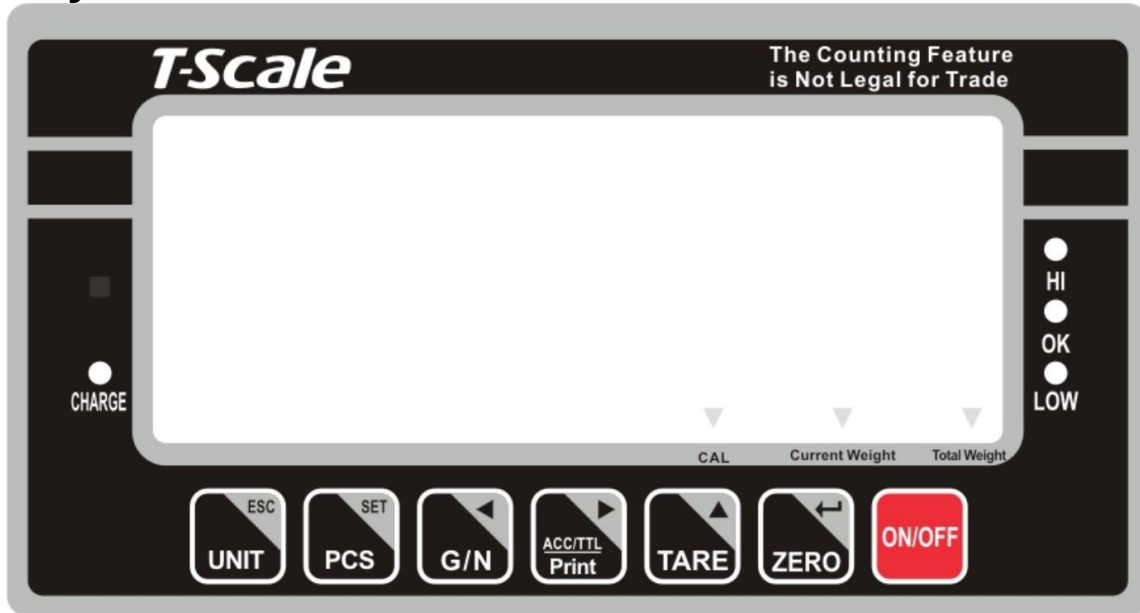

- Place the Indicator on a table or use indicator holder to connect with stand.
- Connect the platform load cell cable in to the indicator load cell connector. Load cell connector is located back side of the indicator.
- Connect the adaptor pin in to the indicator adaptor jack. Adaptor jack is located, back side of the indicator.
- Adaptor connects into your AC power socket. Pluggable equipment must be installed near an easily accessible socket outlet with a protective ground/ earth contact.
- Turn on the On/Off key. If you want to turn off, press the key again.
- Display will show the scale capacity and will be starting self checking.
- After self checking, display will come to normal weighing mode.
- Warm-up time of 15 minutes stabilizes the measured values after switching on.
- Calibrate with exact calibration weights, minimum 1/3 of the scale capacity want to use for calibration. For calibration see details in parameter.

Then you can start your operation







4. KEYS DESCRIPTION

Key Board



Keys	Description
	Power turn ON/OFF
	Set the Zero Display
	To perform a tare function, Subtracts weights.
	Accumulator key, current values will store to the memory, To send the data to printer or PC
	Shift to Gross / Net Weight.
	Counting
	To change the unit

Secondary functions of the keys

Function	Keys
To confirm the selected menu	
To change the menu and active digit	
To move the active digit to right	
To move the active digit to left	
To enter in to the menu	
Escape from the menu to normal operation.	

5. OPERATION

Initial Start-up

Warm-up time of 15 minutes stabilizes the measured values after switching on.

5.1. Basic Operation

1. Power On/Off:

Switch on the balance by pressing on/ off key.

The display is switched on and the test is started and if want to switched off, press again the key.



2. Zero

Environmental conditions can lead to the balance exactly zero in spite of the platform not taking any strain. However, you can set the display of

your balance to zero any time by pressing  key and therefore ensure that the weighing starts at zero.

3. Tare

The weight of any container can be tared by pressing  button so that with subsequent weighing the net weight of the object being weighed is always displayed.

- Load weight on the platform.
- Press  key. Zero is displayed, and tare is subtracted.
- Remove weight on the platform. Tared weight is displayed. It can set only one tare value. It will be shown with a minus value.
- Press G/N to change between gross weight and net weight.
- To clear the tare value, remove the load and press  key. Zero is displayed, tare weight is cleared.













4. Select Unit and Sampling operation

Press  key, it can change unit and sampling operation.





5.2. Check Weighing

It can set an upper or lower limit when weighing with the limits range. During the limit controls dividing the unit will indicate whether a value upper or lower limits with an alarm sound .

5.2.1. Set Limits

- Press  and  key together, display will be show **set h**.
- Press  key to select **set h** or **set l**
- Press  key to confirm, display will show 00000 and will blink the last digit.
- Enter the high limit value by using  and  keys to change the active digits and press  key to increment the value.
- Press  key to confirm, display will show **set l**
- Enter the high limit value by using  and  keys to change the active digits and press  key to increment the value.
- Press  key to confirm.
- To escape from the settings press  key.

5.2.2. Set Check Weighing

- Press  and  key together, display will be show **set h**.
- Press  key to select display **beep** .
- Press  key to confirm, display will be shown **none** or **ok** or **ng**
- **Check mode none** : No beep sound in the limits. Function turned off.
- **Check mode ok** : When the weight is between the limits. OK will shown

and beeper will be sounded.

- **Check mode ng** : When the weight is out of the limits, the beeper will be sounded and OK will shown.

Note: Check weighing available only when weight more than 20d

5.3. Accumulation

The scale can be set to accumulate manually by pressing  key. For settings, see the parameter **p 1 Com » mode » pr 2**
 Before operation scale should be stable and return to zero, accumulation available only when weight more than 20d

Accumulation Operation

- Place the load on the platform.
- Press  key, when displayed STABLE indication.
- Display will be show **acc 1** then will be show the total saved value. These displays will be shown only three seconds.
- Remove the weight from the pan.
- When display get zero and stable then place the second weight.
- It can continue until the memory gets fully or 99 items.

5.3.1 Memory Recall

To recall the memory press  key.

Display will be show **acc X** (X: Total number of accumulation) then will be show the total saved value. These displays will be shown only three seconds.

5.3.2. Memory Clear

To clear the memory, press  and  keys together.

Display will be show **Acc 0** , all accumulation memory cleared from the memory.

5.3.3. Automatically accumulation.

The scale can be set to accumulate automatically. For settings, see the parameter **p 1 Com » mode » auto**

Automatic Accumulation Operation

- Place the load on the platform.
- When display gets STABLE indication, display will be show **acc 1** then will be show the total saved value. These displays will be shown only three seconds.
- Remove the weight from the pan.
- When display get zero and stable then place the second weight.
- It can continue until the memory gets fully or 99 items.

5.4. Parts Counting

To enter the parts counting, press  key and select until display will be show **p 10**

Press  to change the parts quantity.

Options: **p10 / p 20 / p 50 / p100 / p 200**

Parts Counting Operation

- Select the parts quantity as per the option
- Place the load on the platform
- Press  key to confirm, display will be shown **----** then will show the quantity
- Then can add goods on the platform, display will update the parts quantity automatically

Press  key back to the weighing mode..

5.5. Animal Weighing

BW/BWS can use for vibrate loads weigh. This function can use for animal weighing. For settings, see the parameter **p 3 oth » anm**

Bring the load on the platform, when the load few seconds get stable, the reading will be locked for few seconds.

It can add or remove loads also update the weighing locked values.

To enter or exit animal weighing mode, press  key until HOLD indicator will be displayed or not..



When in animal weighing mode **HOLD** indicator will be displayed.

5.6. Keyboard Lock

It can set lock key board, for settings, see the parameter **p 3 oth » lock**





When the keys are not using with in 10 minutes, the keys will be lock automatically.

After entering into the lock function, when we press the keys display will be show **k-1ok**. Then will come to normal display.

If want to unlock and want to use the keys press and hold ,  and  keys three seconds. Display will be show **u 1ck** Then will come to normal display

5.7. Set auto power off

It can set auto power of the scale, when scale not in use, scale will turn off after the setting time.



- Hold  key three seconds display will show **setb1**
- Press  key to change **set of** and press  key to confirm
- Press  key to change the options.

Set of	off	To set auto off function turn off, for scale always on
	of 5	Set to turn off five minutes later
	of 15	Set to turn off fifteen minutes later



- After select the auto off option press  key to confirm and press  key to escape from the settings.

5.8. Set Back Light

It can set back light when scale in use.





- Hold  key three seconds display will show **setbl**
- Press  key to confirm

setbl	au	To set auto option. When start to use back light will be on and when stop the operation back light also will off.
	on	To set always on. After turn on the power, back light also will be on.
	off	To set back light turn off. No back light in the operations

- After select the back light option press  key to confirm and press  key to escape from the settings.

6. PARAMETERS

To set parameter, turn on the scale.

- Press  key during the self checking.
- Display will be show **pn**
- Press , , and  to enter, display will be show **po chk**





Menu	Sub Menu	Description	
P 0 chk	Set H	Set high limits for check weighing	
	Set L	Set low limits for check weighing	
	beep	NONE	No beep for check weighing
		Ok	Beep, when check weighing between the limits
ng		Beep, when check weighing out of the limits	
P 1 com	Mode	<p>This option is used to set accumulation and RS-232 communication</p> <p>Options:</p> <p>Cont : data send continues</p> <p>St 1 : Send data one time, when stable.</p> <p>St c : Send data continuously, when stable</p> <p>P r1 : Send data one time, when press print Key (in printer mode)</p> <p>Pr 2 : Send data to print and accumulation, When press  key</p> <p>Auto : Auto accumulate and auto print mode. When weight stable and return to zero.</p> <p>Ask : Ask mode, Command R: read data Command T: Tare Command Z: Zero</p> <p>Wireles: Wireless mode (communication through wireless)</p>	





	Baud		To set the baud rate. Options: 600 / 1200 / 2400 / 4800 / 9600	
	Pr		To set the parity Options: 7 e1 / 7 o1 / 8 n1	
	Ptype		To set printer model Options: Tpu p : set the Tscale printer tpup Lp50 : Set the Tscale printer LP-50	
P 2 mod	Si g r	To select single range operation		
		Count	To check internal counts	
		Deci	To set decimal points	
		Div	To set increment	
		Cap	Set Capacity	
		Cal	Calibration	
		gra	Gravity	
	Dual 1	To select dual range - mode 1 Note: Once active second interval (div 2), Then second interval will work until display return to zero		
		Count	To check internal counts	
		Deci	To set decimal points	
		Div	Di v 1	To select first division
			Di v 2	To select second division
		Cap	Cap 1	To select first capacity
			Cap 2	To select second capacity
	Cal	Calibration		

		gra	Gravity	
	Dual 2	To select dual interval - mode 2 Note: First interval will active in CAP 1 Second interval will active in CAP 2		
		Count	To check internal counts	
		Deci	To set decimal points	
		Div	Di v 1	To select first division
			Di v 2	To select second division
		Cap	Cap 1	To select first capacity
			Cap 2	To select second capacity
		Cal	Calibration	
	gra	Gravity		
P3 oth	Lock	To set keypad lock Options: on / off		
	anm	To set animal mode. Options: on / off		
P4 ST	ST	To set Multiple tare function Options: on / off		
P5 clr	Clr cal	Clear calibration for the record		
	Clr opt	Clear operation for the record		









7. CALIBRATION

To set calibration, turn on the scale.

- Press  key during the self checking.
- Display will be show **pn**
- Press , , and  to enter, display will be show **po chk**
- Press  until display will be show **p 2 mod.** (These is a switch on the main board you need to press it then can into the parameter)

- Press  key to confirm and press  to select **sigr /dual 1 /dual 2**
- Press  key to confirm and press  to select **cal**
- Press  key to confirm

Calibration Cal

- Press  key to enter calibration, display will show kg or lb. press  key to select the calibration unit kilograms or pounds, press  key, display will be show **unld**
- Remove all the weight from the platform.
- When indicator get stable, press  key to confirm.
- Display will be show the last calibration weight. If want to change the calibration weight value, press  and  keys to change the active digits and press  key to increment the value.
- When the calibration value is correct, press  key to confirm.
- Display will be show **load**
- Place the calibration weight on the platform.
- When indicator get stable, press  key to confirm.
- Display will com to normal weighing mode

8. RS-232 OUTPUT

8.1. Specifications:

RS-232 output of weighing data
 Code : ASCII
 Data bits : 8 data bits
 Parity :No Parity
 Baud rate : 600bps to 9600bps selectable

Decimal point=0, header1=22H
 Decimal point=1, header1=23H
 Decimal point=2, header1=24H
 Decimal point=3, header1=25H
 Decimal point=4, header1=26H
 Header2 follow weigh status, default value=20H
 If in net mode (tare value not 0), header2=header2|01H
 If gross weight “-“, header2=header2|02H
 If overload or gross weight “-“, header2=header2|04H
 If unstable, header2=header2|08H
 If weighing unit=kg, header2=header2|10H
 Header3 follow weighing unit
 If weighing unit=g, header3=21H
 If weighing unit=oz, header3=23H
 Weight1~weight6: weighing data
 Tare1~tare6: tare value
 Terminator1: 0DH
 Terminator2: 0AH

Con3:

Header 0	Header 1	Weight 1	Weight 2	Weight 3	Weight 4	Weight 5	Weight 6	Weight 7	Unit1	Unit2	Status	Termin ator1	Termin ator2
-------------	-------------	-------------	-------------	-------------	-------------	-------------	-------------	-------------	-------	-------	--------	-----------------	-----------------

Header0=01H
 Header1 follow weight “+” or “-“
 When weight “+”, header1=”+”, when weight “-“, header=”-“
 Weight1~weight7: weight data (include decimal point)
 Unit1~unit2: weight unit
 Status: when stable, status=0, when unstable, status=1
 Terminator1: 0DH
 Terminator2: 0AH

9. DRAWING

9.1. BW Drawing

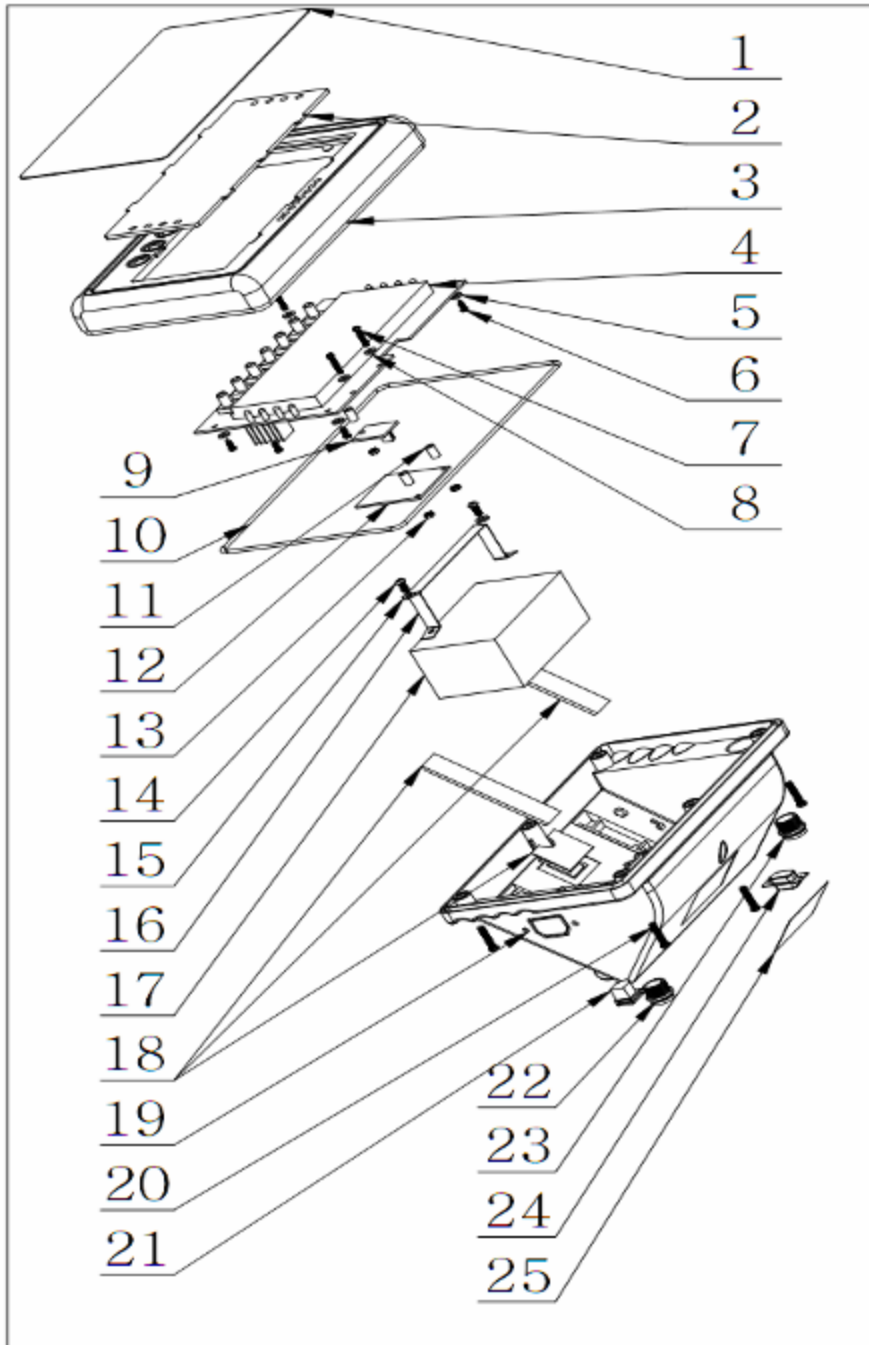

9.2. BW Parts List

No	Parts Name	Qty	Spec
1	Key Panel	1	

2	Display Protection Plate	1	
3	Front Cover	1	
4	Main PCBA	1	
5	Insulation Washer	6	8x3.1x1.5t
6	Self Thread Screw	6	3x10
7	Screw	3	M3x16 (Optional)
8	Insulation Washer	3	8x3.1x1.5t (optional)
9	RS-232 PCBA	1	(Optional)
10	Seal Ring	1	
11	Screw Column	3	5.8x3.8x10H (Optional)
12	Analog Output PCBA	1	
13	Nut	3	M3, Hexagon
14	Self Thread Star (+) Screw	2	4x10
15	Washer	2	9x4.4x0.8t
16	Battery bar	1	
17	Battery	1	6V/4Ah
18	Spacer	2	(Optional)
19	Back Cover	1	ABS
20	Self Thread Star (+) Screw	6	4x116
21	AC Adaptor Jack	1	
22	Air Connector	1	5Pin For load cell
23	Air Connector	1	9Pin for Out Put (Optional)
24	D Connector	1	9 Pin (Optional0
25	Name plate	1	

9.3. BWS Drawing

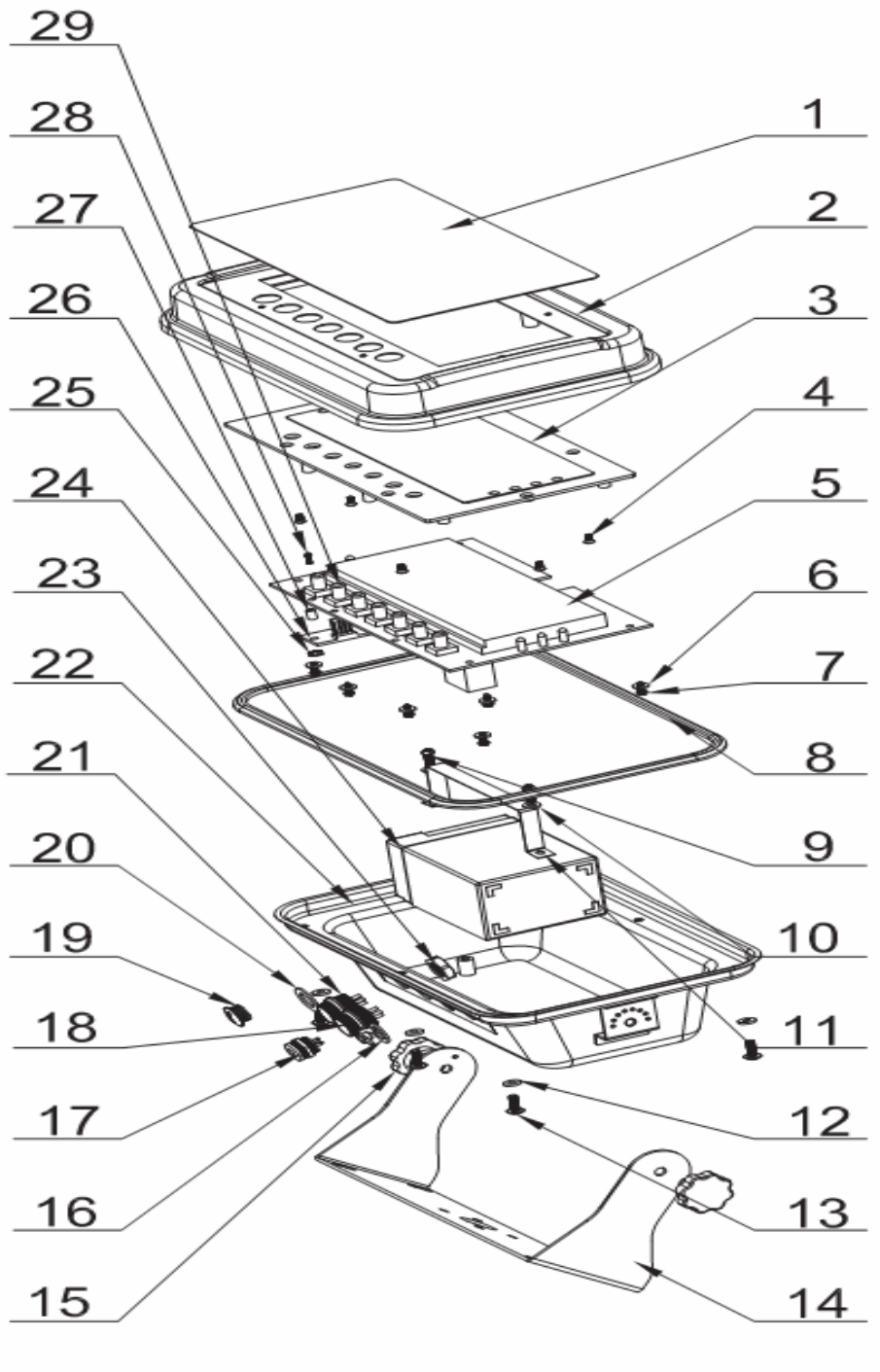

9.4. BWS Parts List

No	Parts	Qty	Spec
1	Key Panel	1	
2	Front Cover	1	
3	Display Protection Plate	1	
4	Nut	6	M3*6
5	Main PCBA	1	
6	Washer	6	8x3.1x1.5
7	Star (+) Self Thread screw	6	M3x8
8	Water Proof Rubber Bar	1	
9	Star (+) Screw	2	M4x10
10	Washer	2	M4
11	Battery Clamp	1	
12	Washer	6	M4
13	Star (+) Big head Screw	6	M4x12
14	Bracket	1	
15	Bracket Screw	2	
16	Water Proof Adaptor jack	1	
17	Interface Module	1	
18	Air connecter	1	5Pin
19	Plug	1	
20	Rubber Spacer	3	
21	Air Connector	1	7Pin
22	Back Cover	1	
23	Air Connector Water Proof Nut	1	
24	Battery	1	6V/4Ah
25	Nut	1	M3x6
26	Main Serial board	1	
27	Spacer	1	
28	Star (+) Screw	1	3Mx20
29	Micro Switch Cap	7	

